



AQUA MAGIC PRO



Owner and Operational Manual

Model: _____
Serial Number: _____
Install Date: _____
Installed By: _____
Service Phone: _____
Sold By: _____



Please read this manual carefully before proceeding with installation. Your failure to follow any of these instructions or operating parameters may lead to personal injury or damage to the equipment and/or personal property. Do not use this water treatment system with water that is microbiologically unsafe or of unknown quality, without adequate disinfection before or after the system. This water treatment system contains replaceable treatment components critical for effective performance. It is the user's responsibility to periodically test the product water to verify the system is performing satisfactorily. Failure to properly maintain this water treatment system may cause a health risk.

Save this manual for future reference

Contents

AM1FB Control Specifications.....	3
Control Valve Function and Cycles of Operation.....	5
Service Instructions.....	6
Drive Assembly.....	6
Drive Cap Assembly, Main Piston, and Regenerant Piston.....	7
Spacer Stack Assembly.....	8
Injector Cap, Screen, Injector Plug, and Injector.....	8
Refill Flow Control Assembly of Refill Port Plug.....	9
Water Meter or Meter Plug.....	9
Bypass Valve.....	10
Front Cover and Drive Assembly.....	11
AM1 Drive Cap Assembly, Downflow Piston, Upflow Piston, Regenerant Piston and Spacer Stack Assembly.....	12
Injector Cap, Injector Screen, Injector, Plug and O-Ring.....	13
Refill Flow Control Assembly and Refill Port Plug.....	14
Drain Line – 3/4”.....	15
Water Meter, Meter Plug and Mixing Valve.....	16
Bypass Valve.....	17
Bypass Valve Operation.....	18
OEM General Programming Instructions.....	19
Proportional Brining.....	21
OEM Configuration Setup.....	22
Note: Clack Twin Alternator Operations.....	24
OEM Softener System Setup.....	28
Setting Options Table ⁴	32
OEM Filter System Setup.....	33
Installer Display Settings.....	35
User Display Settings.....	36
Diagnostics.....	39
Valve History.....	41
Water Treatment System Warranty.....	42

AM1FB Control Specifications

Cycles..... 3 - 6
 Valve Material..... Noryl (1)

FLOW RATES

Service @ 15 psi drop (includes bypass and meter)..... 27 gpm
 Backwash @ 25 psi drop (includes bypass and meter)..... 27 gpm
 Cv Service..... 7.0
 Cv Backwash..... 5.4

OPERATING PRESSURES

Minimum/Maximum..... 20 psi - 125 psi

OPERATING TEMPERATURES

Minimum/Maximum..... 40° - 110° F
 Regeneration..... downflow

METER

Accuracy..... ± 5%
 Flow Rate Range..... 0.25 - 27 GPM
 Gallon Range..... 20 - 50,000

DIMENSIONS

Distributor Pilot..... 1" (1.050) OD Pipe
 Drain Line..... ¾" or 1" NPT
 Brine Line..... ¾" or ½" OD Poly tube
 Mounting Base..... 2 ½" - 8 NPSM
 Height From Top Of Tank..... 7 ¾"
 Weight..... 4.5 lbs.
 Current Draw and Voltage..... A 110v

TANK APPLICATIONS

Water Softener..... 8" - 13" diameter
 Water Filter (2)..... 8" - 13" diameter

CYCLES OF OPERATION (Softener Downflow)

<i>Cycle</i>	<i>Range of times min.</i>
1. Backwash 1 st (upflow). 6 -	12
2. Regenerate Draw (downflow). 45 -	75
3. Backwash 2 nd (upflow). 3 -	12
4. Rinse (downflow). 3 -	8
5. Regenerant Refill (in service with treated water).....	As Programmed
6. Service	

Options: Backwash Filter, ¾" & 1" inlet/outlet, Bypass, Weather Cover

Compatible with the following regenerants or chemicals: Sodium Chloride, potassium chloride, potassium permanganate, sodium bisulfite, sodium hydroxide, hydrochloric acid, chlorine and chloramines

1. Noryl is a trademark of General Electric

Minimum/Maximum Operating Pressures	20 psi (138kPa or 1.4 bar) -125 psi (862 kPa or 8.6 bar)
Minimum/Maximum Operating Temperatures	Minimum/Maximum Operating Temperatures
Power Adapter: Supply Voltage Supply Frequency Output Voltage Output Current	See Drawings and Part Numbers page 1 for data
No user-serviceable parts are on the PC board, the motor, or the power adapter. The means of disconnection from the main power supply is by unplugging the power adapter from the wall.	

The control valve, fittings, and/or bypass are designed to accommodate minor plumbing misalignments but are not designed to support the weight of a system or the plumbing.

Do not use Vaseline, oils, other hydrocarbon lubricants, or spray silicone anywhere. A silicone lubricant may be used on black O-rings but is not necessary. Avoid any type of lubricant, including silicone, on red or clear lip seals.

The nuts and caps are designed to be unscrewed or tightened by hand or with a special plastic wrench. If necessary, pliers can be used to unscrew the nut or cap. Do not use a pipe wrench to tighten or loosen nuts or caps. Do not place screwdriver in slots on caps and/or tap with a hammer.

Do not use pipe dope or other sealants on threads. Teflon tape must be used on the threads of the 1" NPT elbow or the 1/2" NPT connection and on the threads of the drain line connection. Teflon tape is not necessary on the nut connection or caps because of O-rings seals.

After completing any valve maintenance involving the drive assembly or the drive cap assembly and pistons, press and hold NEXT and REGEN buttons for 3 seconds or unplug the power source jack from the printed circuit board (black wire) and plug it back in. This resets the electronics and establishes the service piston position. The display should flash all wording, then flash the software version (e.g. 154), and then reset the valve to the service position.

All plumbing should be done in accordance with local plumbing codes. The pipe size for the drain line should be a minimum of 1/2". Backwash flow rates in excess of 7 gpm or length in excess of 20' require 3/4" drain line.

Solder joints near the drain must be done prior to connecting the drain line flow control fitting. Leave at least 6" between the drain line control fitting and solder joints when soldering pipes that are connected to the drain line control fitting. Failure to do this could cause interior damage to the drain line flow control fitting.

When assembling the installation fitting package (inlet and outlet), connect the fitting to the plumbing system first and then attach the nut, split ring, and O-ring. The heat from soldering or solvent cement may damage the nut, split ring, or O-ring. Solder joints should be cool and solvent cements should be set before installing the nut, split ring, and O-ring. Avoid getting primer and solvent cement on any part of the O-rings, split rings, bypass valve, or control valve.

Plug into an electrical outlet. Note: All electrical connections must be connected according to local codes. (Be certain the outlet is uninterrupted.)

Install grounding strap on metal pipes.

Control Valve Function and Cycles of Operation

This glass filled Noryl¹ fully automatic control valve is designed as the primary control center to direct and regulate all cycles of a water softener or filter. When the control valve is set up as a filter, the control valve can be set to perform down flow regeneration or simply backwash. The control valve can be set to regenerate on demand (consumption of a predetermined amount of water) and/or as a time clock (passage of a particular number of days). The control valve can be set so that a softener can meet the Water Quality Association (WQA) or NSF International efficiency rating.

The control valve is compatible with a variety of regenerates and resin cleaners. The control valve is capable of routing the flow of water in the necessary paths to regenerate or backwash water treatment systems. The injector regulates the flow of brine or other regenerates. The control valve regulates the flow rates for backwashing, rinsing, and the replenishing of treated water into a regenerate tank, when applicable.

The control valve is designed to deliver high service (27gpm @ 15 psi) and backwash (27 gpm @ 25 psi) flow rates when the bypass has straight fittings. The control valve uses no traditional fasteners (e.g. screws), instead clips, threaded caps, nuts, and snap-type latches are used. Caps and nuts only need to be firmly hand tightened because radial seals are used. Tools required to service the valve include one small blade screwdriver, one large blade screwdriver, pliers, and a pair of hands. A plastic wrench is available which eliminates the need for screwdrivers and pliers. Disassembly for servicing takes much less time than comparable products currently on the market. Control valve installation is made easy because the distributor tube can be cut ½" above to ½" below the top of the tank thread. The distributor tube is held in place by an O-ring seal and the control valve also has a bayonet lock feature for upper distributor baskets.

The transformer power pack comes with a 15-foot power cord and is designed for use with the control valve. The transformer power pack is for dry location use only. The control valve remembers all settings for eight hours if the power goes out. After eight hours, the only item that needs to be reset is the time of day, all other values are permanently stored in the nonvolatile memory. If a power loss lasts less than eight hours and the time flashes on and off, the time of day should be reset and the non-rechargeable battery should be replaced.

For DIR Softeners, there are two options for setting the Gallons Capacity. The Gallons Capacity is automatically calculated if set to AUTO. Reserve Capacity is automatically estimated based on water usage if AUTO is used. The other option is to set the Gallons Capacity to a specific number. If a specific number is set, reserve capacity is zero, unless the value is manually set (i.e. the manufacturer intentionally sets the gallon capacity number below the calculated capacity of the system).

The control valve can also be set to regenerate immediately or at the next regeneration time by changing the Regeneration Time Option. There are three choices for settings:

1. "NORMAL" means regeneration will occur at the preset regeneration time.
2. "on 0" means regeneration will occur when the gallons capacity reaches zero.
3. "NORMAL" and "on 0" means the regeneration will occur at the preset regeneration time unless the gallons capacity reaches zero. If the gallons capacity reaches zero the regeneration will begin 10 minutes after no water usage.

The user can initiate manual regeneration. The user has the option to request the manual regeneration at the delayed regeneration time or to have the regeneration occur immediately:

1. Pressing and releasing the REGEN button. "Regen Today" will flash on the display and the regeneration will occur at the delayed regeneration time. The user can cancel the request by pressing and releasing the REGEN button. This method of manually initiating regeneration is not allowed when the system is set to immediately regenerate when the gallon capacity reaches zero.
2. Pressing and holding the REGEN button for approximately 3 seconds will immediately start the regeneration. The user cannot cancel this request, except by resetting the control by pressing NEXT and REGEN buttons simultaneously for 3 seconds.

Service Instructions

Drive Assembly

Remove the valve cover to access the drive assembly.

Disconnect the power source plug (black wire) from the PC board prior to disconnecting the motor or water meter plugs from the PC board. The motor plug connects to the two-pin jack on the left-hand side of the PC board. The power source plug connects to the four-pin jack. The four-pin jack is between the two-pin and three-pin jacks. The water meter plug (gray wire) connects to the three-pin jack on the far right-hand side of the PC board.

The PC board can be removed separately from the drive bracket but it is not recommended. Do not attempt to remove the display panel from the PC board. Handle the board by the edges. To remove the PC board from the drive bracket, unplug the power, water meter, and motor plugs from the PC board. Lift the middle latch along the top of the drive bracket while pulling outward on the top of the PC board. The drive bracket has two plastic pins that fit into the holes on the lower edge of the PC board. Once the PC board is tilted about 45° from the drive bracket it can be lifted off of these pins. To reinstall the PC board, position the lower edge of the PC board so that the holes in the PC board line up with the plastic pins. Push the top of the PC board towards the valve until it snaps under the middle latch, weave the power and water meter wires into the holders, and reconnect the motor, water meter, and power plugs.

The drive bracket must be removed to access the drive cap assembly and pistons or the drive gear cover. It is not necessary to remove the PC board from the drive bracket to remove the drive bracket. To remove the drive bracket, start by removing the plugs for the power source and the water meter. Unweave the wires from the side holders. Two tabs on the top of the drive back plate hold the drive bracket in place. Simultaneously lift the two tabs and gently ease the top of the drive bracket towards your body. The lower edge of the drive bracket has two notches that rest on the drive back plate. Lift up and outward on the drive bracket to disengage the notches.

To reassemble, seat the bottom of the drive bracket so the notches are engaged at the bottom of the drive back plate. Push the top of the drive bracket towards the two latches. The drive bracket may have to be lifted slightly to let the threaded piston rod pass through the hole in the drive bracket. Maintain a slight engaging force on top of the drive bracket while deflecting the bracket slightly to the left by pressing on the side of the upper right corner. This helps the drive gears mesh with the drive cap assembly. The drive bracket is properly seated when it snaps under the latches on the drive back plate. If resistance is felt before latching, then notches are not fully engaged, the piston rod is not in the hole, the wires are jammed between the drive bracket and drive back plate, or the gear is not engaging the drive cap assembly.

To inspect drive gears, the drive gear cover needs to be removed. The drive gear cover is held in place on the drive bracket by three clips. The largest of the three clips is always oriented to the bottom of the drive bracket. Before trying to remove the drive gear cover, the drive bracket must be removed from the drive back plate. The drive gear cover can be removed from the drive bracket without removing the motor or the PC board. Simultaneously, push in and down on the large clip at the bottom and the clip on the left-hand side of the drive bracket behind the PC board. Keep your fingers behind the drive gear cover so the drive gears do not drop on the ground.

Replace broken or damaged drive gears. Do not lubricate any of the gears. Avoid getting any foreign matter on the reflective coating because dirt or oils may interfere with pulse counting.

The drive gear cover only fits on one way, with the large clip orientated towards the bottom. If all three clips are outside of the gear shroud on the drive bracket the drive cover slips easily into place.

The drive bracket does not need to be removed from the drive plate if the motor needs to be removed. To remove the motor, disconnect the power and motor plugs from the jacks on the PC board. Move the spring clip loop to the right and hold. Rotate the motor at least a ¼ turn in either direction before gently pulling on the wire connectors to remove the motor. Pulling directly on the wires without rotating the motor may break the wires off the motor.

Replace the motor if necessary. Do not lubricate the motor or the gears. When reinstalling the motor gently turn the motor while inserting so that the gear on the motor meshes with the gears under the drive gear cove and the small plastic bulge engages one of the slots on the motor housing. Reconnect the motor plug to the two-pronged jack on the lower left-hand side of the PC board. If the motor will not easily engage with the drive gear when reinstalling, lift and slightly rotate the motor before reinserting.

Replace the valve cover. After completing any valve maintenance, press and hold NEXT and REGEN buttons for 3 seconds or unplug the power source jack (black wire) and plug it back in. This resets the electronics and establishes the service piston position. The display should flash all wording, then flash the software version (e.g. 154), and then reset the valve to the service position.

Drive Cap Assembly, Main Piston, and Regenerant Piston

The drive must be removed to access the drive cap assembly. The drive cap assembly must be removed to access the piston(s). The drive cap assembly is threaded into the control valve body and seals with an O-ring. To remove the drive cap assembly, use the special plastic wrench or insert a $\frac{1}{4}$ " to $\frac{1}{2}$ " flat bladed screwdriver into one of the slots around the top 2" of the drive cap assembly so it engages the notches molded into the drive back plate around the top 2" of the piston cavity. See Figure 5. The notches are visible through the holes. Lever the screwdriver so the drive cap assembly turns counter clockwise. Once loosened unscrew the drive cap assembly by hand and pull straight out.

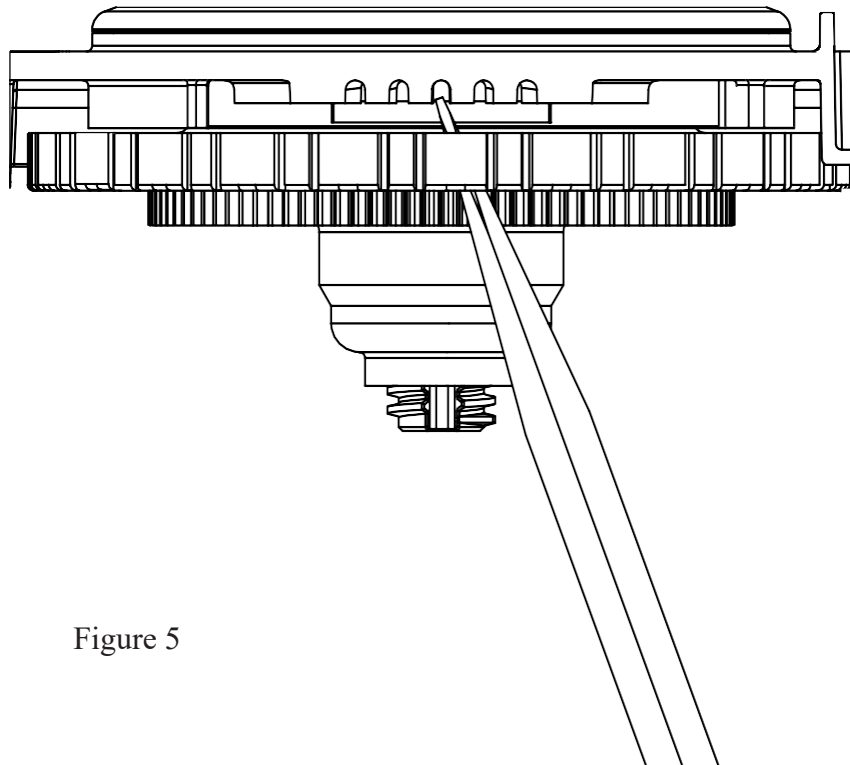

Figure 5

The drive cap assembly contains the drive cap, the main drive gear, the drive cap spline, the piston rod, and various other parts that should not be disassembled in the field. The only replaceable part on the drive cap assembly is the O-ring. Attached to the drive cap assembly is the main piston (down flow or up flow) and if a regenerant is used, a regenerant piston.

The regenerant piston (the small diameter one behind the main piston) is removed from the main piston by unsnapping it from its latch. Chemically clean in dilute sodium bisulfite or vinegar or replace the regenerant piston if needed. To remove the main down flow or up flow piston fully extend the piston rod and then unsnap the main piston from its latch by pressing on the side with the number. Chemically clean in dilute sodium bisulfite or vinegar or replace the main piston.

Reattach the main piston to the drive cap assembly. Reattach the regenerant piston (if needed) to the main piston. Do not lubricate the piston rod, main piston, or regenerant piston. Lubricant will adversely affect the red or clear lip seals. Reinsert the drive cap assembly and piston into the spacer sack assembly and hand tighten the drive cap assembly. Continue to tighten the drive cap assembly using a screwdriver as a ratchet until the black O-ring on the spacer stack assembly is no longer visible through the drain port. Excessive force can break the notches molded into the drive back plate. Make certain that the main drive gear still turns freely. The exact position of the piston is not important as long as the main drive gear turns freely.

Reattach the drive assembly to the control valve and connect all plugs. After completing any valve maintenance, press and hold NEXT and REGEN buttons for 3 seconds or unplug the power source jack (black wire) and plug it back in. This resets the electronics and establishes the service piston position. The display should flash all wording, then flash the software version (e.g. 154), and then reset the valve to the service position.

Spacer Stack Assembly

To access the spacer stack assembly, remove the drive assembly, drive cap assembly, and piston. The spacer stack assembly can be removed easily without tools by using your thumb and forefinger. Inspect the black O-rings and red or clear lip seals for wear or damage. Replace the entire stack if necessary. The spacer stack assembly has been 100% tested at the factory to ensure the proper orientation of one-way seals. Do not disassemble the stack.

The spacer stack assembly may be chemically cleaned (dilute sodium bisulfite or vinegar) or wiped with a soft cloth.

The spacer stack assembly can be pushed into the control valve body bore by hand. Since the spacer stack assembly can be compressed it is easier to use a blunt object (5/8" to 1-1/8" in diameter) to push the center of the assembly into the control valve body. The assembly is properly seated when at least four threads are exposed (approximately 5/8"). Do not force the spacer stack assembly in. The control valve body bore interior can be lubricated with silicone to allow for easy insertion of the entire stack.

Reattach the drive cap assembly and piston(s) and the drive assembly.

After completing any valve maintenance, press and hold NEXT and REGEN buttons for 3 seconds or unplug the power source jack (black wire) and plug it back in. This resets the electronics and establishes the service piston position. The display should flash all wording, then flash the software version (e.g.154), and then reset the valve to the service position.

Injector Cap, Screen, Injector Plug, and Injector

Unscrew the injector cap and lift off. Loosen the cap with a special plastic wrench or pliers if necessary. Attached to the injector cap is a screen. Remove the screen and clean it if fouled.

The plug and/or injector can be pried out with a small screwdriver. The plug can be wiped clean. If the plug leaks replace the entire plug. The injector consists of a throat and a nozzle. Chemically clean the injector with vinegar or sodium bisulfite. The holes can be blown out with air. Both pieces have small diameter holes that control the flow rates of water to ensure that the proper concentration of regenerant is used. Sharp objects, which can score the plastic, should not be used to clean the injector. Scoring the injector or increasing the diameter of the hole could change the operating parameters of the injector.

Two holes are labeled DN and UP. Check for compliance with one of the following:

- a. for down flow systems, the appropriate size injector is located in the “DN” hole, a plug is in the “UP” hole, and the piston is a combination of the down flow main piston and the regenerate piston;
- b. for up flow systems, the appropriate size injector is located in the “UP” hole, a plug is in the “DN” hole, and the piston is a combination of the up flow main piston and the regenerant piston; or
- c. for backwash only systems, a plug is in the “DN” hole and in the “UP” hole, and the piston only has a down flow main piston (the regenerant piston must be removed) and a plug is in the refill flow control position.

Push the plug(s) and/or injectors firmly in place, replace the screen and hand tighten the injector cap.

Refill Flow Control Assembly of Refill Port Plug

To clean or replace the refill flow control, pull out the elbow-locking clip and then pull straight up on the elbow. Replace the elbow locking clip in the slot so that it is not misplaced. Twist to remove the white flow control retainer. The flow control can be removed by prying upward through the side slots of the retainer with a small blade flat screwdriver.

Chemically clean the flow control or the white flow control retainer using dilute sodium bisulfate or vinegar. Do not use a wire brush. If necessary, replace the flow control, O-ring on the flow control retainer, or the O-ring on the elbow.

Reseat the flow control so the rounded end is visible in the flow control. Reseat the white flow control retainer by pushing the retainer into the elbow until the O-ring seats. Remove the locking clip, push down on the elbow to reseat, and insert the locking clip.

Do not use Vaseline, oils, or other unacceptable lubricants on O-rings. A silicon lubricant may be used on the O-ring on the elbow or the white retainer.

Water Meter or Meter Plug

The water meter assembly is connected to the PC board by a wire. If the entire water meter assembly is to be replaced, remove the control valve cover and remove the power source and water meter plugs from the PC board. Unlatch the drive assembly and lean it forward. Unthread the water meter wire from the side of the drive assembly and through the drive back plate. To reinstall, rethread the water meter wire through the drive back plate and the side of the drive assembly. Reattach the drive assembly, the water meter, and power plugs.

If no water meter wire is visible, then a plug is installed not a water meter.

The water meter wire does not need to be removed from the PC board if the water meter is only being inspected and cleaned. To remove the water meter assembly, unscrew the meter cap on the left side of the control valve. Pliers may be used to unscrew the nut if necessary.

With the nut removed, a slot at the top of the water meter is visible. Twist a flat blade screwdriver in the slot between the control valve body and the meter. When the meter is part way out it is easy to remove the water meter from the housing. Once the water meter is removed from the control valve body, use your fingers to gently pull forward on the turbine to remove it from the shaft.

Do not use a wire brush to clean. Wipe with a clean cloth or chemically clean in dilute sodium bisulfite or vinegar. The turbine can be immersed in the chemical. Do not submerge electronics. If the turbine is scored or damaged or the bearings on the turbine are worn replace the turbine.

Do not lubricate the turbine shaft. The turbine shaft bearings are pre-lubricated. Do not use Vaseline, oils, or other unacceptable lubricants on the O-ring. A silicon lubricant may be used on the black O-ring.

Snap the turbine on the shaft and reinsert the water meter into the side slot. Hand tighten the nut, do not use a pipe wrench to tighten nut.

Bypass Valve

The working parts of the bypass valve are the rotor assemblies that are contained under the bypass valve caps. Before working on the rotors, make sure the system is depressurized. Turn the red arrow shaped handles towards the center of the bypass valve and back to the arrow direction several times to ensure the rotor is turning freely.

The nuts and caps are designed to be unscrewed or tightened by hand. If necessary, pliers can be used to unscrew the nut or cap. Do not use a pipe wrench to tighten or loosen nuts or caps. Do not place screwdriver in slots on caps and/or tap with a hammer. To access the rotor, unscrew the cap and lift the cap, rotor, and handle out as one unit.

Twisting the unit as you pull it out will help to remove it more easily. There are three O-rings: one under the rotor cap, one on the rotor stem, and the rotor seal. Replace worn O-rings. Clean rotor. Reinstall rotor.

When reinstalling the red arrow handles be sure that:

1. O-rings on both rotors face to the right when being viewed from the front of the control valve when the handle pointers are lined up with the control valve body arrows; or
2. Arrows point toward each other in the bypass position.

Since the handles can be pulled off, they could be accidentally reinstalled 180° from their orientation. To install the red arrow handles correctly, keep the handles pointed in the same direction as the arrows engraved on the control valve body while tightening the bypass valve caps.

After completing any valve maintenance, press and hold NEXT and REGEN buttons for 3 seconds or unplug the power source jack (black wire) and plug it back in. This resets the electronics and establishes the service piston position. The display should flash all wording, then flash the software version (e.g. 154), and then reset the valve to the service position.

Front Cover and Drive Assembly

Drawing No.	Order No.	Description	Quantity
1	V4441-01	FB COVER ASY	1
2	V3107-01	AM1 MOTOR ASY	1
3	V3002-A	AM1 DRIVE BRACKET ASY	1
4	V4461FB-BOARD	AM1THRU2 FB PCB REPLACE	1
5	V3110	AM1 DRIVE REDUCING GEAR 12X36	3
6	V3109	AM1 DRIVE GEAR COVER	1
Not Shown	V3186-06	AM1 POWER SUPPLY US 15VDC HOCP	1
	V3186AUS-05OD	AM1 POWER SUPPLY AUS 15VDC VI OUTDOOR	
	V3186EU-06	AM1 POWER SUPPLY EU 15VDC HOCP	
	V3186UK-06	AM1 POWER SUPPLY UK 15VDC HOCP	
	V3186-01	AM1 POWER CORD ONLY	
Not Shown	V3946	AM1 WIDE DRIVE BACK PLATE	1

Refer to Control Valve Service Manual for other drawings and part numbers.

Relay Driver Output Type – Dual Solid-State 12VDC “wet” contacts - N.O. Relay Driver Output Capacity - 12VDC @100mA per relay output (total current through both outputs not to exceed 200mA).

NOTE: Check for proper mounting dimensions on valve backplate prior to mounting an external relay under control cover.

Power Supply	U.S.	International
Supply Voltage	100-120 VAC	100-240 VAC
Supply Frequency	50/60 Hz	50/60 Hz
Output Voltage	15 VDC	15 VDC
Output Current	500 mA	500 mA

Wiring for Correct On/Off Operation	
PC Board Relay Terminal Block	Relay
RLY 1	Coil -
V +	Coil +
RLY 2	Coil -

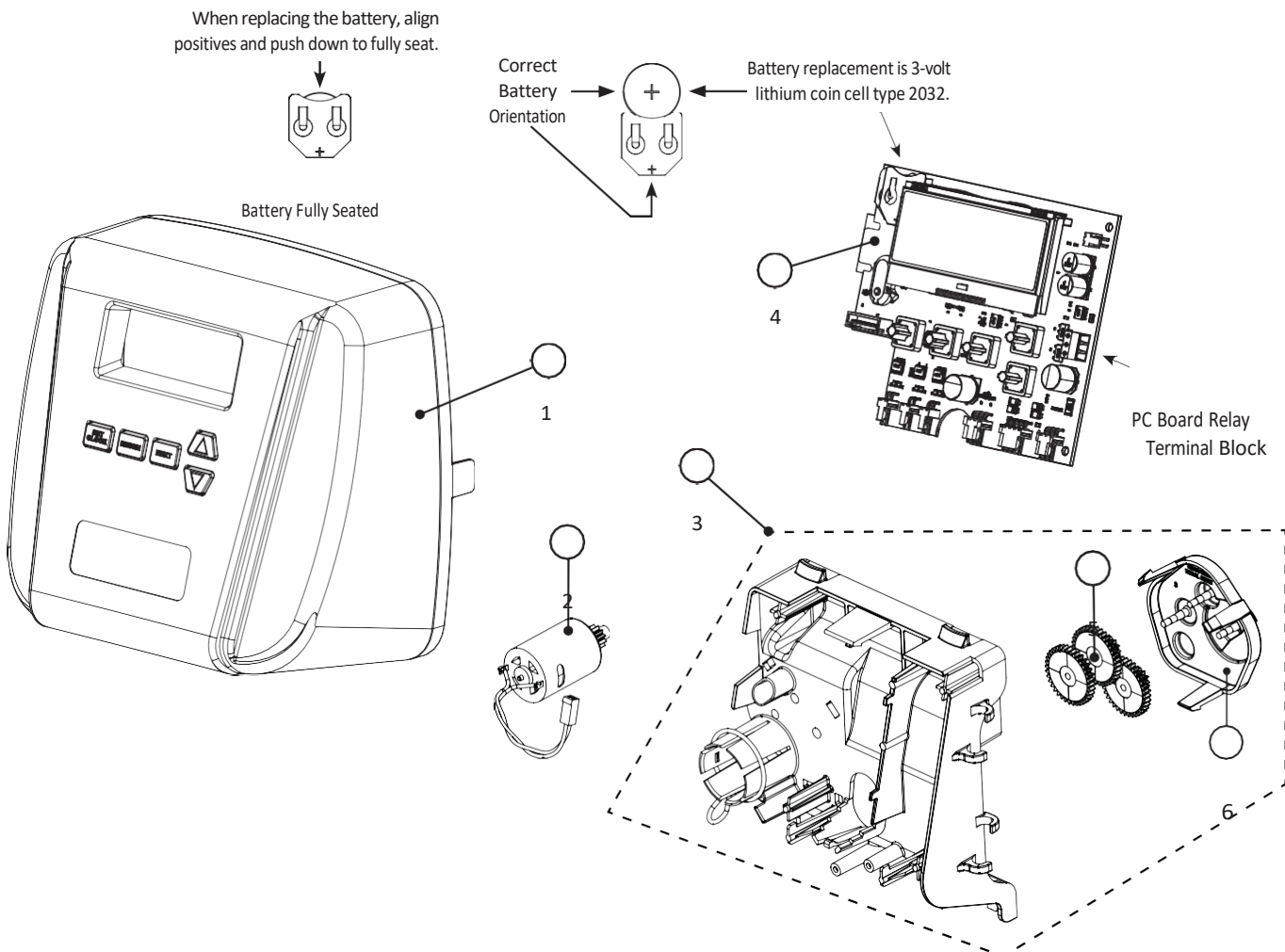

AM1 Drive Cap Assembly, Downflow Piston, Upflow Piston, Regenerant Piston and Spacer Stack Assembly

Drawing No.	Order No.	Description	Quantity
1	V3005-02	AM1 Spacer Stack Assembly	1
2	V3004	Drive Cap ASY	1
3	V3178	Refer to Programming and Cover Drawing Manual	1
4a	V3011*	AM1 Piston Downflow ASY	1
4b	V3011-01*	AM1 Piston Upflow ASY	
5	V3174	AM1 Regenerant Piston	1
6	V3135	O-ring 228	1
7	V3180	O-ring 337	1
8	V3105	O-ring 215 (Distributor Tube)	1
Not Shown	V3001	AM1 Body ASY Downflow	1
	V3001-02	AM1 Mixing Valve Body ASY	
	V3001UP	AM1 Body ASY Upflow	
	V3001-02UP	AM1 Mixing Valve Body Upflow ASY	
Not Shown	V3193-02	AM1 Service Spanner Wrench	

*V3011 is labeled with DN and V3011-01 is labeled with UP. The upflow option does not apply to TC control valves.

Note: The regenerant piston is not used in backwash-only applications.

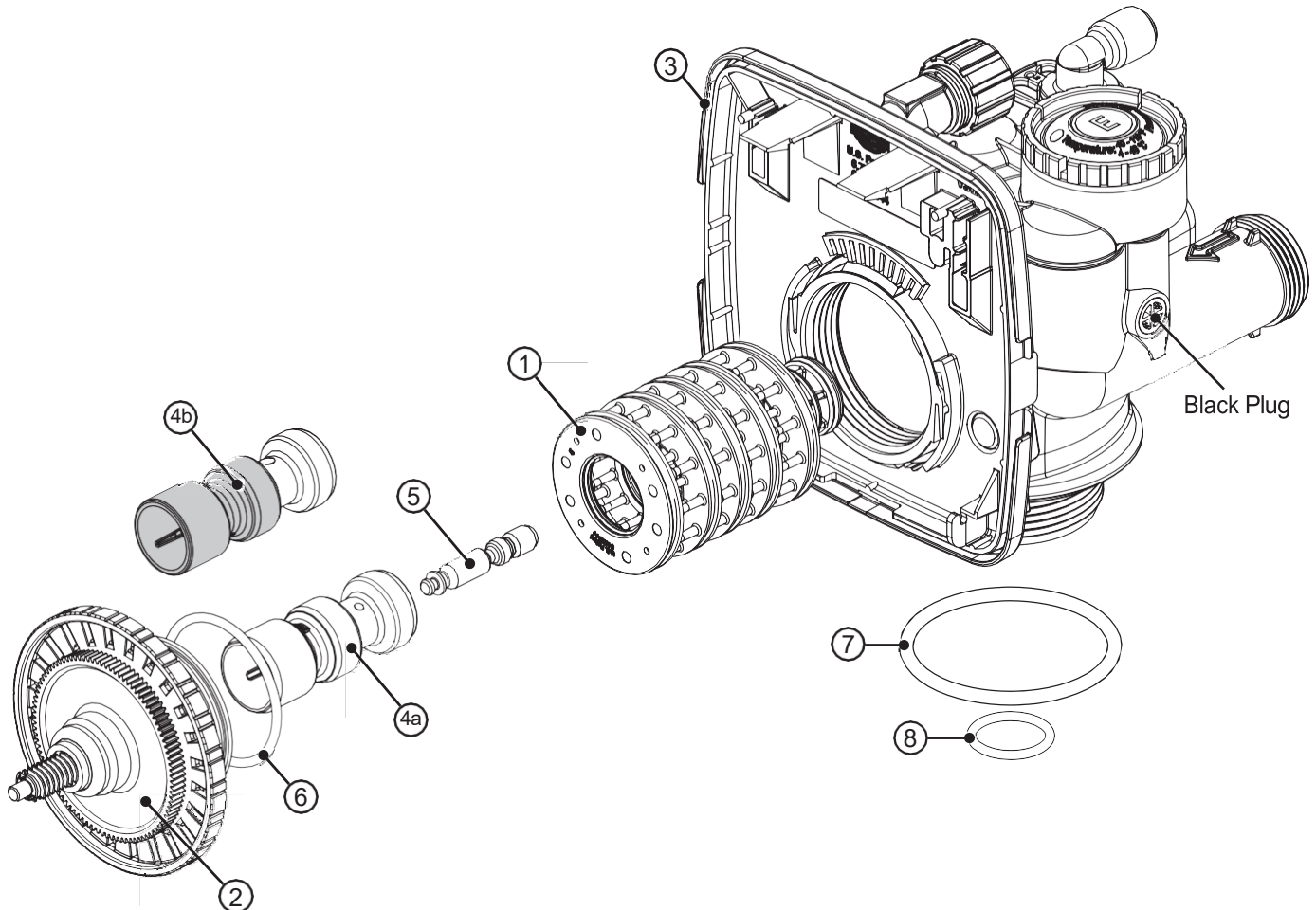

Injector Cap, Injector Screen, Injector, Plug and O-Ring

Drawing No.	Order No.	Description	Tank Size	Quantity
1	V3176	Injector Cap		1
2	V3152	O-Ring 135		1
3	V3177-01	Injector Screen Cage		1
4	V3010-1Z	AM1 Injector Asy Z Plug		1
5	V3010-1C	AM1 Injector Asy C Violet	8	1
	V3010-1D	AM1 Injector Asy D Red	9	
	V3010-1E	AM1 Injector Asy E White	10	
	V3010-1F	AM1 Injector Asy F Blue	12	
	V3010-1G	AM1 Injector Asy G Yellow	13	
Not Shown	V3170	O-Ring 011		*
Not Shown	V3171	O-Ring 013		*

* The injector plug and the injector each contain one 011 (lower) and 013 (upper) O-ring.

Note: For upflow position, the injector is located in the up hole and the injector plug is in the other hole.

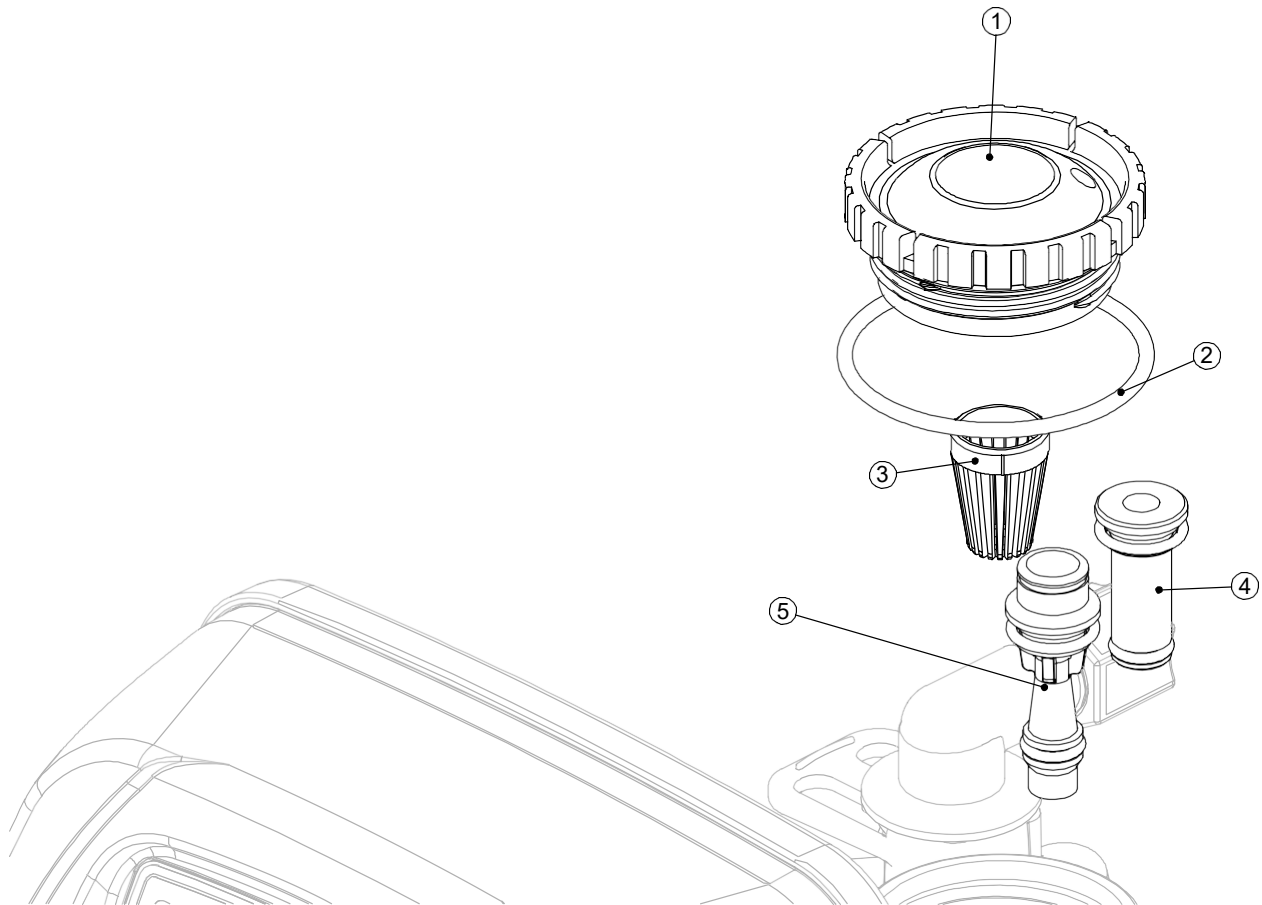

Refill Flow Control Assembly and Refill Port Plug

Drawing No.	Order No.	Description	Quantity
1	V3195-01	AM1 Refill Port Plug Assy	This part is required for backwash only systems
2	H4615	Elbow Locking Clip	1
3	H4628	Elbow 3/8" Liquifit	1
4	V3163	O-ring 019	1
5	V3165-01*	AM1 RFC Retainer Assy (0.5 gpm)	1
6	V3182	AM1 RFC	1
7	V4144-01	Elbow 3/8 Liquifit Assy w/RFC	1
Not Shown	V3552	AM1 Brine Elbow Assy w/RFC	Option
Not Shown	H4650	Elbow 1/2" with nut and insert	Option

*Assembly includes V3182 AM1 (0.5 gpm) RFC.

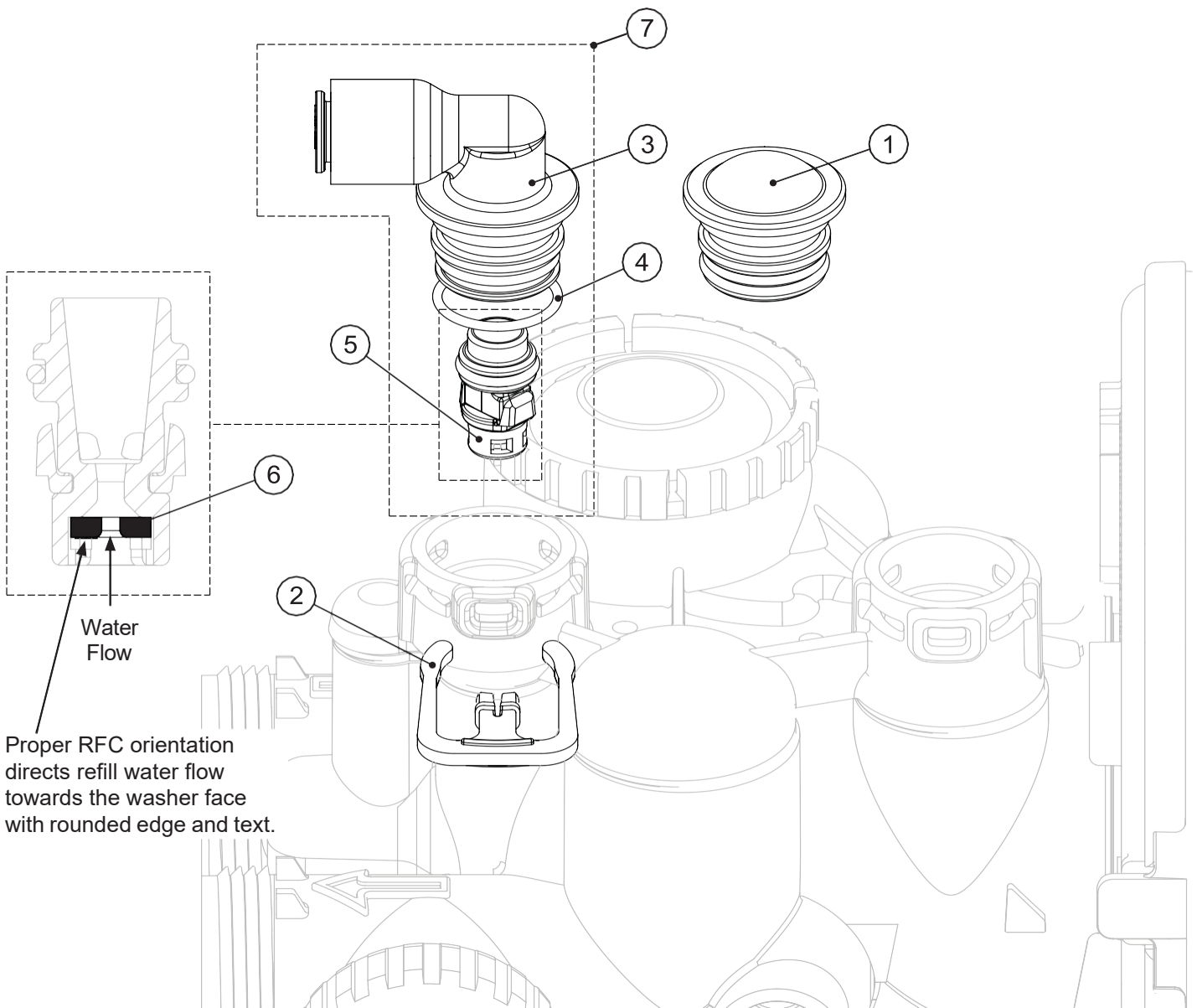

Drain Line – 3/4"

Drawing No.	Order No.	Description	Tank Size	Quantity
1	H4615	Elbow Locking Clip		1
2	PKP10TS8-BULK	Polytube insert 5/8		Option
3	V3192	AM1 Nut 3/4 Drain Elbow		Option
4*	V3158-01	AM1 Drain Elbow 3/4 Male		1
5	V3163	O-ring 019		1
6*	V3159-01	AM1 DLFC Retainer ASY		1
7	V3162-017	AM1 DLFC 1.7 gpm for 3/4	8	1
	V3162-022	AM1 DLFC 2.2 gpm for 3/4	9	
	V3162-027	AM1 DLFC 2.7 gpm for 3/4	10	
	V3162-032	AM1 DLFC 3.2 gpm for 3/4	12	
	V3162-042	AM1 DLFC 4.2 gpm for 3/4	13	

*4 and 6 can be ordered as a complete assembly - V3331 AM1 Drain Elbow and Retainer Asy

Valves are shipped without drain line flow control (DLFC) - install DLFC before using.
 Valves are shipped without 3/4 nut for drain elbow (polytube installation only) and
 5/8" polytube insert (polytube installation only).

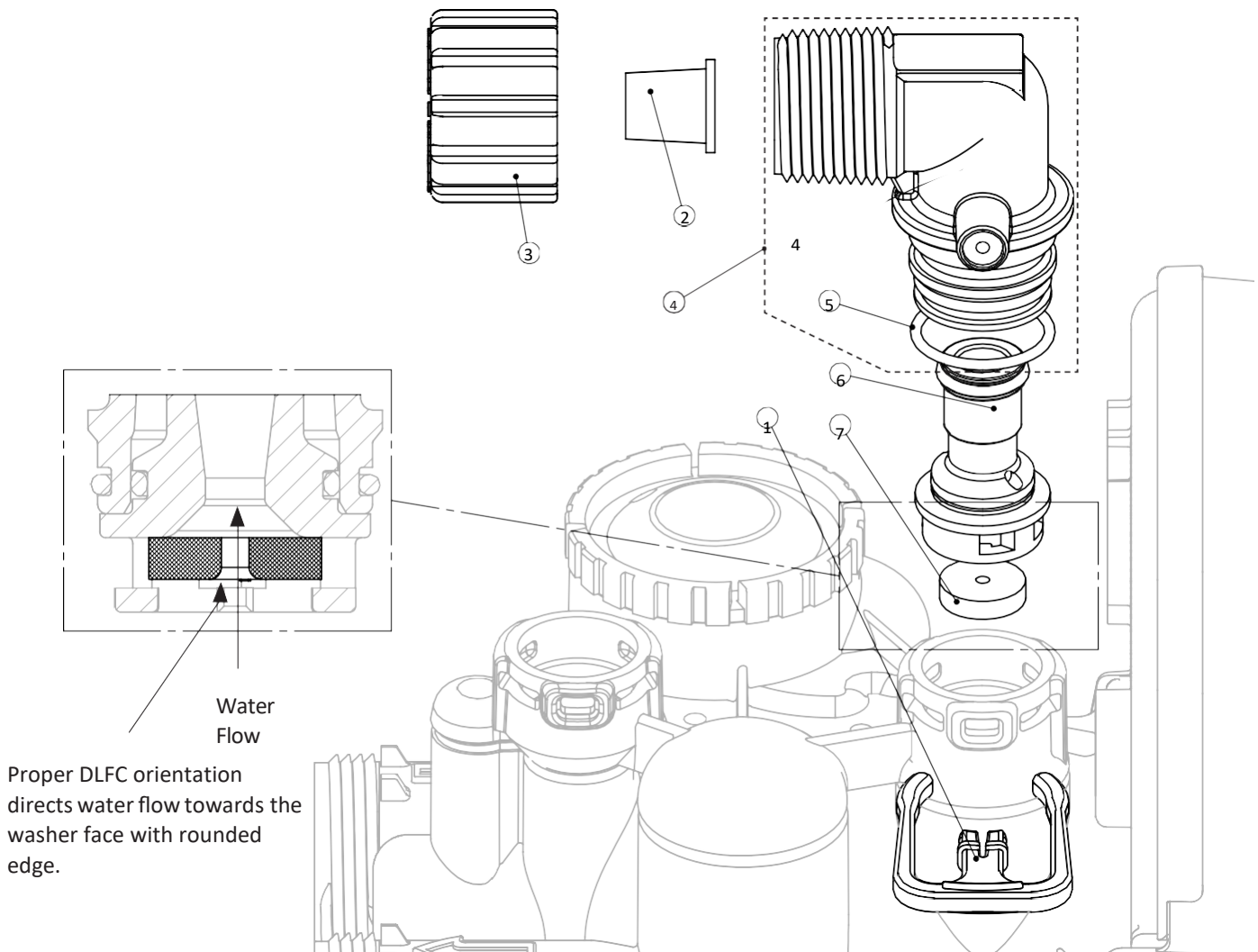

Water Meter, Meter Plug and Mixing Valve

Drawing No.	Order No.	Description	Quantity
1	V3151	AM1 Nut 1" QC	1
2	V3003*	AM1 Meter ASY	1
3	V3118-01	AM1 Turbine ASY	1
4	V3105	O-ring 215	1
5	V3003-01	AM1 Meter Plug ASY	1
6	V3013	Mixing Valve	Optional

*Order number V3003 includes V3118-01 AM1 Turbine ASY and V3105 O-ring

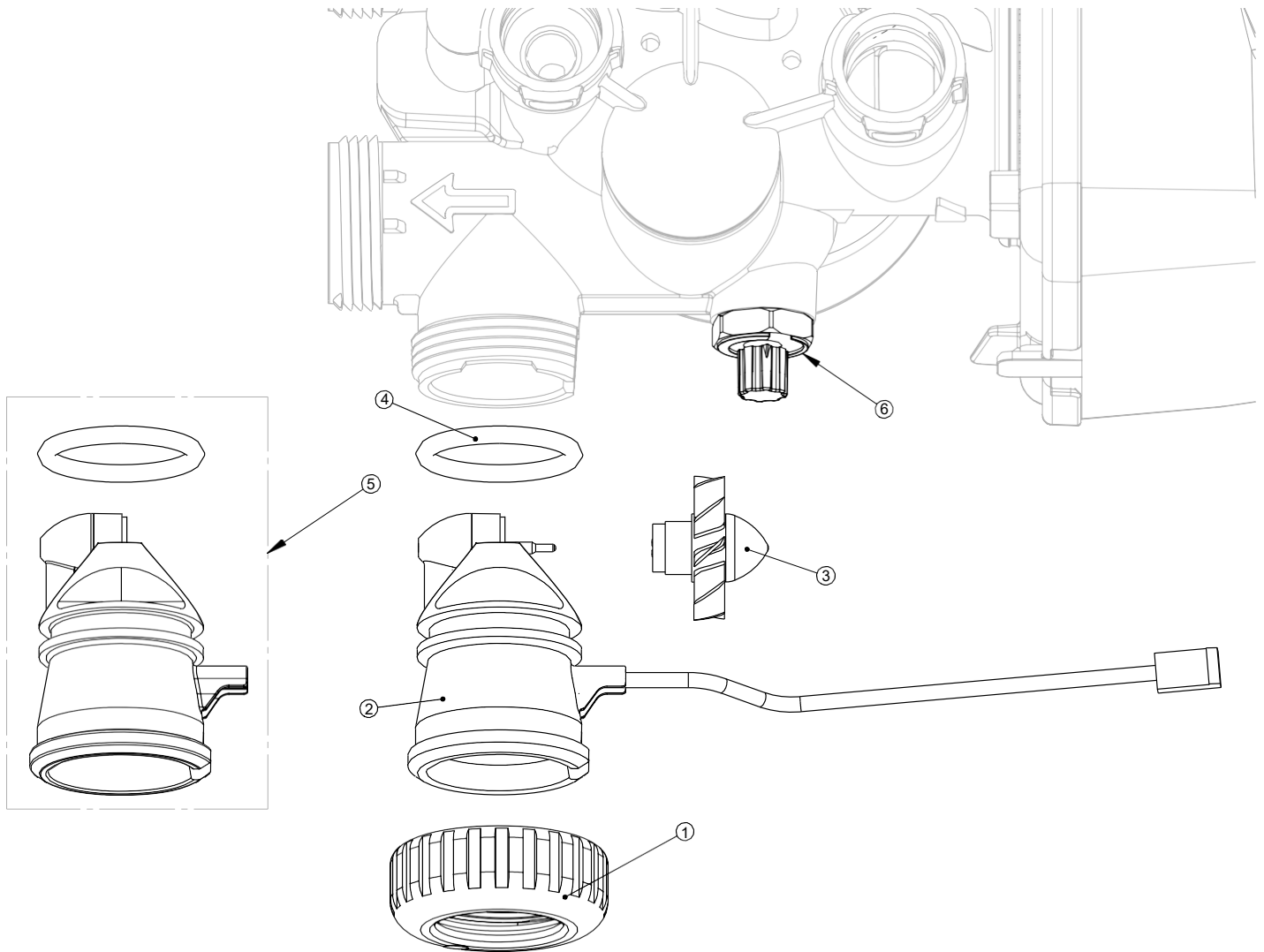

THIS WATER METER SHOULD NOT BE USED AS THE PRIMARY MONITORING DEVICE FOR CRITICAL OR HEALTH EFFECT APPLICATIONS.

NOTE: A water meter is not applicable for a TC control valve.

Bypass Valve

Drawing No.	Order No.	Description	Quantity
1	V3151	AM1 Nut 1" Quick Connect	2
2	V3150	AM1 Split Ring	2
3	V3105	O-Ring 215	2
4	V3145	AM1 Bypass 1" Rotor	2
5	V3146	AM1 Bypass Cap	2
6	V3147	AM1 Bypass Handle	2
7	V3148	AM1 Bypass Rotor Seal Retainer	2
8	V3152	O-ring 135	2
9	V3155	O-ring 112	2
10	V3156	O-ring 214	2

(Not Shown) Order No. V3191-01, Description: AM1 Bypass Vertical Adapter Assembly

Order No.	Description	Quantity
V3151	AM1 Nut 1" Quick Connect	2
V3150	AM1 Split Ring	2
V3105	O-Ring 215	2
V3191	AM1 Bypass Vertical Adapter	2

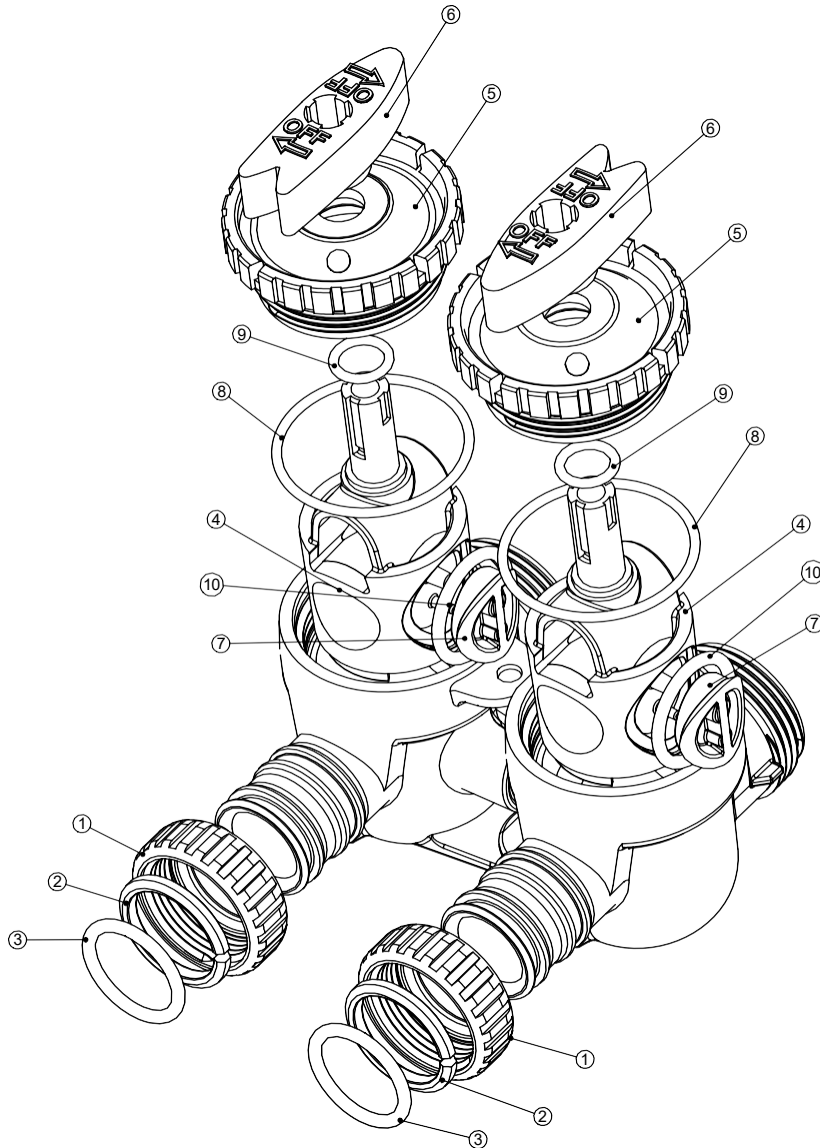

Bypass Valve Operation

Figure 1

NORMAL OPERATION

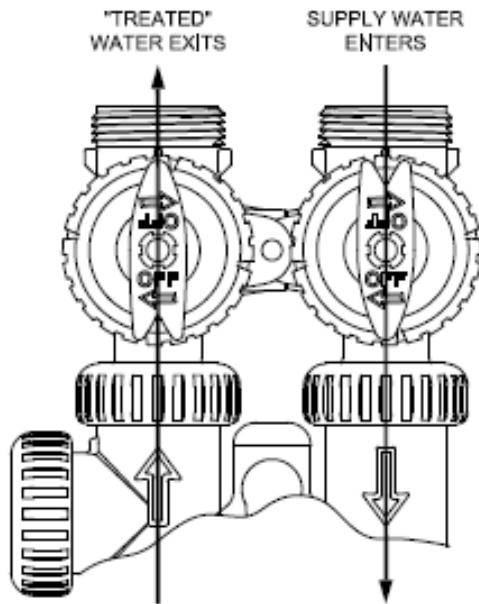

Figure 2

BYPASS OPERATION

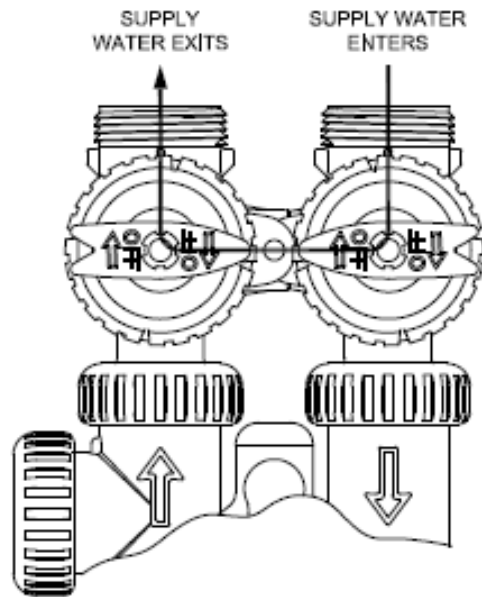

Figure 3

DIAGNOSTIC MODE

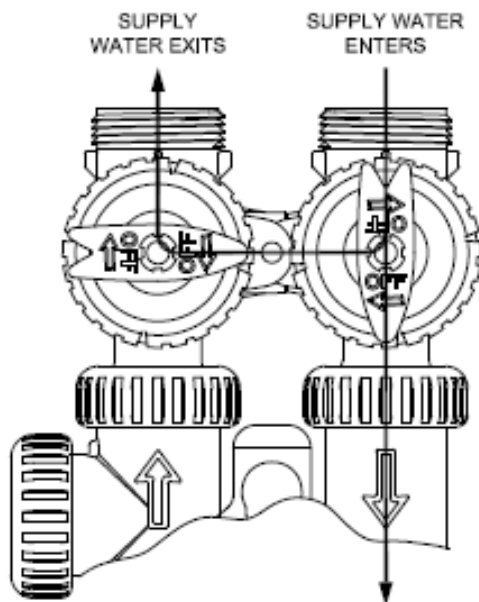
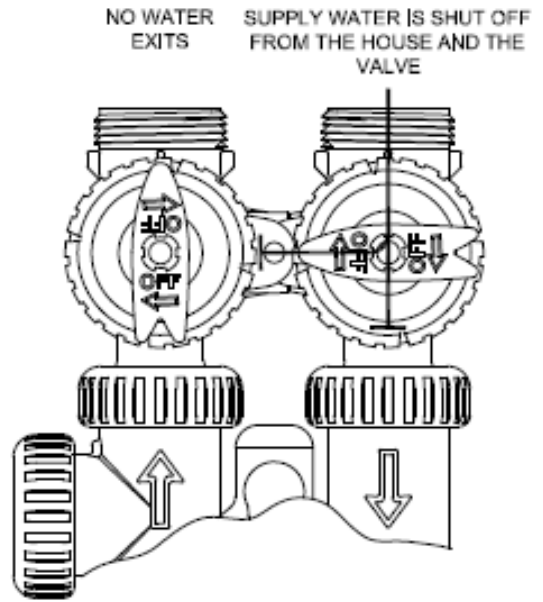

Figure 4

SHUT OFF MODE



OEM General Programming Instructions

The control valve offers multiple procedures that allow the valve to be modified to suit the needs of the installation. These procedures are:

- OEM Configuration Setup
- OEM Softener System Setup
- OEM Filter System Setup
- Installer Display Settings
- User Display Settings
- Diagnostics
- Valve History

Tables 1 and 2 show examples when the valve is set up as a softener or filter.

Table 1: Regeneration Cycles Softening

Downflow Regenerant Refill After Rinse	Downflow Regenerant Prefill	Upflow Regenerant Refill After Rinse	Upflow Regenerant Prefill
1 st Cycle: Backwash 2 nd Cycle: dn Brine 3 rd Cycle: Backwash 4 th Cycle: Rinse 5 th Cycle: Fill	1 st Cycle: Fill 2 nd Cycle: Softening 3 rd Cycle: Backwash 4 th Cycle: dn Brine 5 th Cycle: Backwash 6 th Cycle: Rinse	1 st Cycle: UP Brine 2 nd Cycle: Backwash 3 rd Cycle: Rinse 4 th Cycle: Fill	1 st Cycle: Fill 2 nd Cycle: Softening 3 rd Cycle: UP Brine 4 th Cycle: Backwash 5 th Cycle: Rinse

Table 2: Regeneration Cycles Filtering

Downflow Regenerant Refill After Rinse
1 st Cycle: Backwash 2 nd Cycle: dn Brine 3 rd Cycle: Backwash 4 th Cycle: Rinse 5 th Cycle: Fill

The control valve with a water meter can be set for Demand Initiated Regeneration (DIR) only, Time Clock operation only, or DIR and Time Clock whichever comes first, depending upon what settings are selected for Day Override and Gallon Capacity.¹ See Table 3.

If a control valve does not contain a meter, the valve can only act as a time clock, and day override should be set to any number, and gallon capacity should be set to off.

**Table 3
DIR/Time Clock Options**

DIR	Time Clock	Reserve Capacity	Softener	Filter		Settings ²	
				Regenerant	Backwash Only	Days to REGEN	Gallon Capacity
Yes		Automatically calculated	Yes			Off	Auto
Yes		If desired enter a value less than estimated capacity	Yes	Yes	Yes	Off	Any Number
Yes	Yes	Automatically calculated	Yes			Any Number	Auto
Yes	Yes	If desired enter a value less than estimated capacity	Yes	Yes	Yes	Any Number	Any number
	Yes	None	Yes	Yes	Yes	Any Number	Off

For DIR Softeners, there are two options for setting the Gallons Capacity. The Gallons Capacity is automatically calculated if set to AUTO. Reserve Capacity is automatically estimated based on water usage if AUTO is used. The other option is to set the Gallons Capacity to a specific number. If a specific number is set, reserve capacity is zero, unless the value is manually set (i.e. the manufacturer intentionally sets the gallon capacity number below the calculated capacity of the system).

A unique feature of this control valve is the ability to display actual water usage for the last 63 days. The values are initially stored as “-----”.

This means the value is unknown. As days pass values are stored as "0" for no flow or the actual number of gallons. The counting of the gallons starts at the regeneration time. If no regeneration time can be set (i.e. when the valve is set for immediate regeneration) the counting of gallons starts at 12 a.m. Day 1 is yesterday, day 2 the day before yesterday, etc. As new values are added the oldest history disappears.

Another unique feature is that the valve automatically calculates a reserve capacity when set up as a softener with "Gallons Capacity" set to "AUTO" and the "Regeneration Time Option" set to "DELAYED REGEN" or "DELAY + IMMEDIATE". The actual reserve capacity is compared to the gallons capacity remaining immediately prior to the preset regeneration time. Regeneration will occur if the actual reserve capacity is less than the gallons capacity remaining. The actual reserve capacity is calculated by using the estimated reserve capacity and adjusting it up or down for actual usage.

The estimated reserve capacity for a given day of the week is the maximum value stored for the last three non-trivial water usages (i.e. more than 20 gallons/day) in seven-day intervals.

¹ See Installer Display Settings, OEM Softener System Setup, and OEM Filter System Setup for explanations of Day Override and Gallon Capacity.

² Days to REGEN and Gallon Capacity cannot both be set to "OFF" at the same time.

Once the OEM Cycle Sequence has been set, the other procedures can be accessed in any order. Details on each of the procedures are provided on the following pages.

To “lock out” access to diagnostic and valve history displays and modifications to settings except for hardness, day override, time of regeneration, and time of day by anyone but the manufacturer, press ▼, NEXT, ▲, and CLOCK in sequence after settings are made. To “unlock”, so other displays can be viewed and changes can be made, press ▼, NEXT, ▲, and CLOCK in sequence.

When in operation normal user displays such as time of day, volume remaining before regeneration, present flow rate, or days remaining before regeneration are shown. When stepping through a procedure, if no buttons are pressed within five minutes, the display returns to a normal user display. Any changes made prior to the five minute time out are incorporated.

To quickly exit OEM Softener Setup, OEM Filter Setup, Installer Display Settings, Diagnostics, or Valve History press CLOCK. Any changes made prior to the exit are incorporated.

To clear the Service Call reminder, press ▲ and ▼ simultaneously while CALL is displayed.

When desired, all programming and information in Diagnostics may be reset to defaults when the valve is installed in a new location. To reset to defaults, press NEXT and ▼ simultaneously to go to the Softening/Filtering screen. Press ▲ and ▼ simultaneously to reset programming and diagnostic values to defaults. The screen will return to User Display.

Sometimes it is desirable to have the valve initiate and complete two regenerations within 24 hours and then return to the preset regeneration procedure. It is possible to do a double regeneration if the control valve is set to “DELAYED REGEN” or “DELAY + IMMEDIATE” in OEM Softener System Setup or OEM Filter System Setup. To do a double regeneration:

1. Press the “REGEN” button once. REGEN TODAY will flash on the display.
2. Press and hold the “REGEN” button for three seconds until the valve regeneration initiates.

Once the valve has completed the immediate regeneration, the valve will regenerate one more time at the preset regeneration time.

For Valve Type 1.0T, press and hold CLOCK and ▲ for about 3 seconds to initiate an exchange of the tank in Service without cycling the regeneration valve. After tank switch, days remaining and capacity remaining status is retained for each tank until the next regeneration.

Proportional Brining

If the system is set up as a prefill upflow softener the control valve can also be set to normal or proportional brining.



This step will appear after Step 8S and before Step 9S if the system is set up as a prefill upflow softener. The following options can be selected:

- NORMAL FILL - System always prefills with the salt level selected.
- PROPORTIONAL FILL - If proportional brining is selected, the actual salt fill time will be calculated by dividing the actual volume of treated water used by the full volumetric capacity, then multiplying this value by the maximum salt fill time.

Press NEXT to go to the next step. Press REGEN to return to the previous step.

OEM Configuration Setup

STEP 1CS

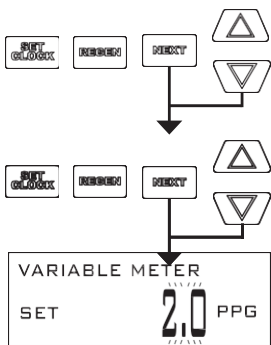

Step 1CS – Press NEXT and ▼ simultaneously for 3 seconds and release. Then press NEXT and ▼ simultaneously for 3 seconds and release. If screen in Step 2CS does not appear in 5 seconds the lock on the valve is activated. To unlock press ▼, NEXT, ▲, and CLOCK in sequence, then press NEXT and ▼ simultaneously for 3 seconds and release. Then press NEXT and ▼ simultaneously for 3 seconds and release.

STEP 2CS

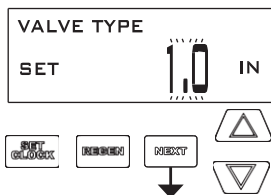

Step 2CS – Use ▲ or ▼ 1.0 for 1" valve, 1.25 for 1.25" valve, 1.5 for 1.5" valve, 2.0 for 2" valve or 1.0T for the twin valve.
Press NEXT to go to Step 3CS.
Press REGEN to exit the OEM cycle sequence.

STEP 3CS

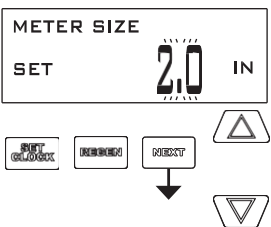

Step 3CS – When 1.5 or 2.0 is selected, an additional screen will appear. It is used to select which size flow meter is to be used with the valve 1.0r, 1.5, 2.0, or 3.0. Variable meter pulses of 0.1-150.0 PPG can also be selected.
Press NEXT to go to Step 4CS.
Press REGEN to return to the previous step.

STEP 4CS



Step 4CS – Allows selection of one of the following using ▲ or ▼:

- the Control Valve to act as an alternator; or
- the Control Valve to have a no hard water bypass: or
- the Control Valve to have a Separate Source during the regeneration cycle; or
- the control valve to operate as part of a Progressive Flow system; or
- the Control Valve to operate with the Clack System Controller. Select OFF when none of these features are used.

Only use Clack No Hard Water Bypass Valves or Clack Motorized Alternating Valves (MAV) with these selections. Clack No Hard Water Bypass Valves (1" or 1.25" V3070FF or V3070FM) are not designed to be used with the alternator function or separate source.

This display will not appear if 1.0T is selected in Step 2CS. Selecting the Control Valve to act as an alternator:

Prior to starting the programming steps, connect the interconnect cable to each control valve board's three pin connector labeled COMM CABLE. Also connect the meter cord to either control valve to the three pin connector labeled METER.			
		Softener valve programming steps	
OEM Configuration Setup	Step 4CS	Set to ALT A Connect the outlet plumbing of the ALT A valve to the MAV's A port and connect the MAV's two pin wire connector to the two pin connector labeled MAV on the ALT A valve	Set to ALT B Connect the outlet plumbing of the ALT B valve to the MAV's B port. No electrical connections are required between the ALT B valve and the MAV
Softener System Setup	Step 9S	Set to AUTO	Set to AUTO
Softener System Setup	Step 10S	Set regeneration time option to IMMEDIATE.	Set regeneration time option to IMMEDIATE.
Installer Display Setting	Step 4I	Set Day Override to OFF	Set Day Override to OFF

If set up for a filter, in Step 7F set Volume Capacity in Gallons; in Step 8F select Regeneration Time Option "Immediate"; and in Step 3I select Day Override "OFF".

For Clack Corporation alternator systems using **AM1, AM1.25 and AM1.5** valves there will be an option to delay the last two cycles of regeneration (only Rinse and Fill). This feature splits the regeneration into two portions. The first portion of the regeneration will start immediately and all programmed cycles before the Rinse and Fill cycles will be performed. After all programmed cycles before Rinse and Fill are completed the control valve will drive to the service position (displaying Delayed Rinse + Fill Pending). When the volume of the on-line unit is depleted to 10% of its programmed capacity, the control valve will be triggered to finish the second portion of the regeneration. Once Rinse and Fill are completed, the valve will re-enter Standby mode until requested to come on-line for Service.

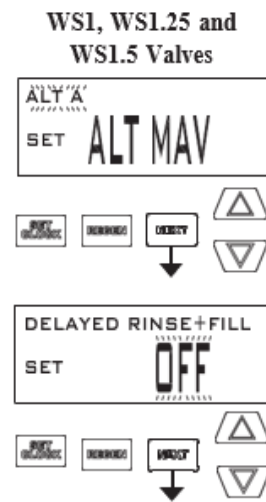

For Clack Corporation alternator systems using the **AM2** valve, when NEXT is pressed after selecting ALT A or ALT B, a display will allow the user to set the amount of pre-service rinse time for the stand-by tank just prior to returning to service.

With 1.0T set, the same display appears and is set in a similar manner.

Note: Clack Twin Alternator Operations

- Twin alternating systems can be programmed with a day override setting combined with the normal volume-based regeneration programming. A twin alternating system in this configuration will then regenerate based on the volume used or the day override if there is a period of low water usage.
- Twin alternating systems can be programmed as a time clock only based regenerating system. In this configuration, the days remaining are counted only on the unit that is in service. The unit in Stand-by Mode only notes days in diagnostics, which results in time clock only twin regeneration initiation.
- Twin alternating systems can be programmed for a delayed regeneration time. The system will allow an immediate transfer of the MAV to switch tanks and place a fully regenerated unit in service once a unit becomes exhausted. The exhausted unit will then be placed into Stand-by Mode and allowed to have a delayed regeneration at the pre-set time

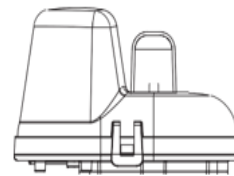

Retracted

Valve A in Service Position = MAV piston rod Retracted

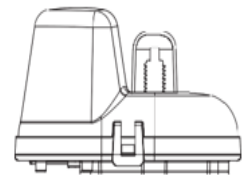

Extended

Valve B in Service Position = MAV piston rod Extended

Configuring the Control Valve for No Hard Water Bypass Operation:

Select NO HARD BYPASS for control operation. For no hard water bypass operation, the three wire connector is not used. Selection requires that a connection to MAV or a Clack No Hard Water Bypass Valve is made to the two pin connector labeled MAV located on the printed circuit board. If using a MAV, the A port of the MAV must be plugged and the valve outlet connected to the B port. When set to No Hard Bypass the MAV will be driven closed before the first regeneration cycle that is not FILL or SOFTENING or FILTERING, and be driven open after the last regeneration cycle that is not FILL. NOTE: If the control valve enters into an error state during regeneration mode, the no hard water bypass valve will remain in its current state until the error is corrected and reset.

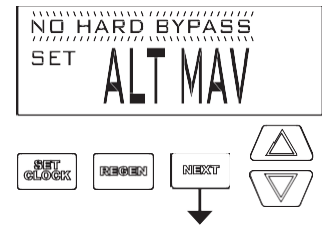

Configuring the Control Valve for Separate Source Operation:

Select SEPARATE SOURCE for control operation. For separate source operation, the three wire connector is not used. Selection requires that a connection to a Clack Motorized Alternator Valve (MAV) is made to the two pin connector labeled MAV located on the printed circuit board. The C port of the MAV must be connected to the valve inlet and the A port connected to the separate source used during regeneration. The B port must be connected to the feed water supply. When set to Separate Source the MAV will be driven closed before the first regeneration cycle, and be driven open after the last regeneration cycle. NOTE: If the control valve enters into an error state during regeneration mode, the MAV will remain in its current state until the error is corrected and reset.

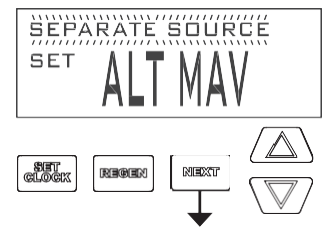

Configuring the valve for Progressive Flow operation:

Select Progressive Flow from the Alt MAV Output Operation display. Operation in Progressive Flow Mode requires 2 to 4 valves plumbed in parallel, each with a separate flow meter and No Hard Water Bypass unit. For proper progressive flow operation, three-wire communication cables are required to be connected to each valve in the system via the 3-pin Comm Cable connector.

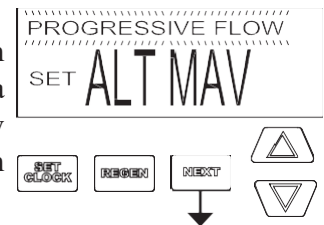

NOTE: All cabling must be connected before starting initial valve programming. Once all valves in the system have their COMM CABLE inputs connected AND are fully programmed, perform a Next/Regen Reset on each valve to initiate normal system operation.

Press NEXT to go to the UNIT NAME display. Set the UNIT NAME as required by the position of the control valve in the system. Each Valve needs to be set to Progressive Flow and have different addresses, 1, 2, 3, and 4. Valve 1 will be the controlling valve of the system.

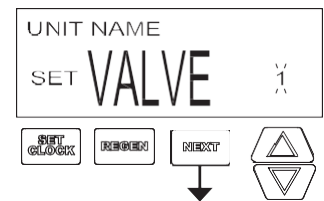

If setting Valve 1, press NEXT to go to the ADD ANOTHER UNIT display and set the required flow rate adder value. The ADD ANOTHER UNIT setting will add or subtract the number of units currently in service, based on the overall flow rate through the system. The ADD ANOTHER UNIT screen will only appear on Valve 1.

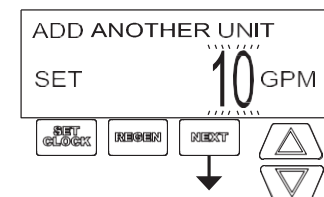

Complete valve setup by pressing NEXT to advance through the remaining displays and make any other required changes prior to exiting programming.

Configuring the Control Valve to operate with Clack System Controller:

Select SYSTEM CONTROLLER to link the Control Valve to the Clack System Controller. For communication between the Control Valve and the System Controller a three wire communication cable is required.

Press NEXT to go to Step 5CS. Press REGEN to return to previous step.

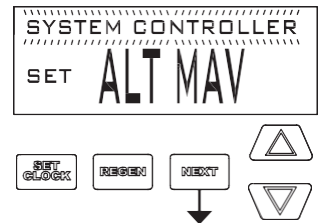

STEP 5CS

Step 5CS – Set Auxiliary Drive Output (MAV only) to operate in one of two modes:

-TIME – Output is activated at a set time after the start of regeneration, for a specified length of time.

-Set SEP SOURCE: Allows Auxiliary MAV to switch positions before the start of regeneration and then switch back at the end of regeneration.

-Set OFF: Deactivates this output.

Only use Clack Motorized Alternating Valves (MAV) with these selections. Clack No Hard Water Bypass Valves (1" or 1.25" V3070FF or V3070FM) are not designed to be used with the TIME or SEPARATE SOURCE functions.

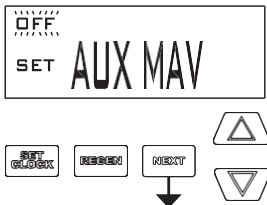

STEP 5CS

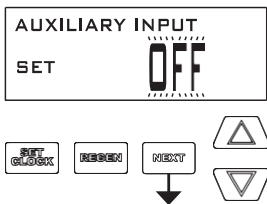

Press NEXT to go to Step 6CS. Press REGEN to return to the previous step.

Step 6CS – This allows the use of an outside signal to control the initiation of a regeneration. Selection only matters if a connection is made to the two pin connector labeled DP SWITCH located on the printed circuit board. Following is an explanation of the options:

OFF – Feature not used.

NOTE: In a twin alternating system each control must have a separate dP signal or dP switch. One dP signal or one dP switch cannot be used for both controls.

IMMED REG – If the dP switch is closed for an accumulative time of 2 minutes a regeneration will be signaled to the unit. In a twin alternating system the MAV will transition first to switch units so that the signaled unit can start regeneration. After the MAV is fully transitioned the regeneration begins immediately. Note: For AM1 – AM1.5 control valves programmed for twin alternating: if the dP function “IMMED REG” is set, the Delayed Rinse and Fill feature is not available.

DELAY REG – If the dP switch is closed for an accumulative time of 2 minutes a regeneration will occur at the scheduled delayed regeneration time. In a twin alternating system once the dP switch is triggered the PC Board will display “REGEN TODAY” and when the delayed regen time comes the control will switch tanks and the triggered unit will then go into regeneration. Note: For AM1 – AM1.5 control valves programmed for twin alternating: if the dP function “DELAY REG” is set, the Delayed Rinse and Fill feature is not available.

HOLD REG – If the dP switch is closed a regeneration will be prevented from occurring while there is switch closure. In a twin alternating system the regeneration of a unit can be prevented upon switch closure. If the unit depletes the capacity down to zero it will not be allowed to switch tanks to regenerate until the switch is open. Note: For AM1 – AM1.5 control valves programmed for twin alternating the Delayed Rinse and Fill feature can be set in conjunction with the “HOLD REG” if desired.

Press NEXT to go to Step 7CS or to exit Configuration Setup. Press REGEN to return to previous step.

STEP 7CS **Step 7CS** – If set as a softener, and 1.5 was selected in Step 2CS, this screen will appear, and FILL can be set to LBS or MIN by using ▼ or ▲. Press NEXT to exit Configuration Setup. Press REGEN to return to previous step.

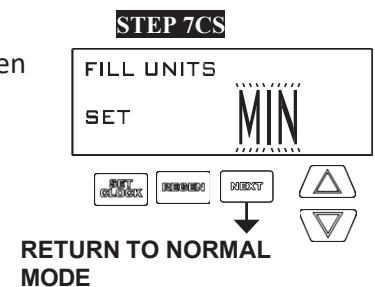

OEM Softener System Setup

Type	Fill	Service	Backwash	Draw	Backwash	Rinse	Fill
Softening DN Post			8	60	8	8	9.5 LBS
Softening DN Pre	9.5 LBS	240	8	60	8	8	
Softening UP Post				60	8	8	9.5 LBS
Softening UP Pre	9.5 LBS	240		60	8	8	
Softening DN Post 2.0" Valve			8	60	8	8	6 MIN
Softening DN Pre 2.0" Valve	6 MIN	240	8	60	8	8	

Cycle	Units	Range	Default
Backwash	MIN	1-120 or OFF	8
Rinse	MIN	1-120 or OFF	8
Draw (Up or Down)	MIN	1-160 or OFF	60
Fill (all but 2" valve)	LBS	0.1-200 or OFF	9.5
Fill (1.5" MIN or 2" valve)	MIN	0.1-99.0 or OFF	6
Softening	MIN	1-480 or OFF	240

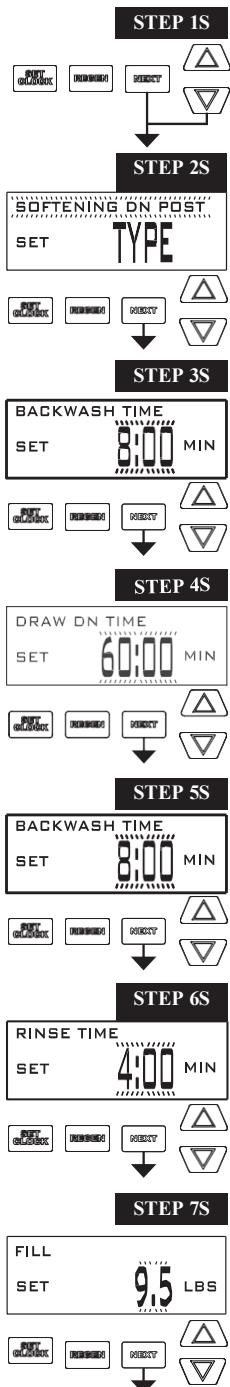

Step 1S – Press NEXT and ▼ simultaneously for 3 seconds and release. If screen in Step 2S does not appear in 5 seconds the lock on the valve is activated. To unlock press ▼, NEXT, ▲, and CLOCK in sequence, then press NEXT and ▼ simultaneously for 3 seconds and release.

Step 2S – Choose the SOFTENING program desired (see table) using ▼ or ▲. Press NEXT to go to Step 3S. Press REGEN to exit OEM Softener System Setup.

Step 3S – Select the time for the first cycle using ▼ or ▲. Press NEXT to go to Step 4S. Press REGEN to return to previous step.

Step 4S – Select the time for the second cycle using ▼ or ▲. Press NEXT to go to Step 5S. Press REGEN to return to previous step.

Step 5S – Select the time for the third cycle using ▼ or ▲. Press NEXT to go to Step 6S. Press REGEN to return to previous step.

Step 6S – Select the time for the fourth cycle using ▼ or ▲. Press NEXT to go to Step 7S. Press REGEN to return to previous step.

Step 7S – Select the LBS for the fifth cycle using ▼ or ▲. If 2.0 was selected in Step 2CS, or MIN was selected in Step 7CS, FILL is in minutes. Press NEXT to go to Step 8S. Press REGEN to return to previous step.

STEP 8S

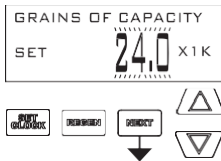

Step 8S –Set Grains Capacity using ▲ or ▼. The ion exchange capacity is in grains of hardness as calcium carbonate for the system based on the pounds of salt that will be used. Calculate the pounds of salt using the fill time previously selected. Grains capacity is affected by the fill time. The grains capacity for the selected fill time should be confirmed by OEM testing. The capacity and hardness levels entered are used to automatically calculate reserve capacity when volume capacity is set to AUTO. Press NEXT to go to Step 9S. Press REGEN to return to previous step.

STEP 9S

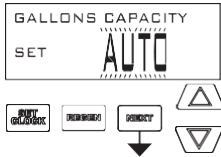

Step 9S – Set Volume Capacity using ▲ or ▼. If value is set to:

- AUTO capacity will be automatically calculated and reserve capacity will be automatically estimated;
- OFF regeneration will be based solely on the day override set (see Installer Display Settings Step 3I); or
- a number, regeneration initiation will be based off the value specified.

If OFF or a number is used, hardness display will not be allowed to be set in Installer Display Settings Step 2I.

If OFF is selected, Regeneration Time is automatically “Delayed”, so Step 10S will not appear.

See Setting Options Table for more detail. Press NEXT to go to Step 10S. Press REGEN to return to previous step.

STEP 10S

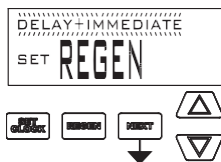

Step 10S – Set Regeneration Time Options using ▼ or ▲. If value is set to:

- DELAYED REGENERATION means regeneration will occur at the preset time;
- IMMEDIATE REGENERATION means regeneration will occur immediately when the volume capacity reaches 0 (zero); or
- DELAY + IMMEDIATE REGENERATION means regeneration will occur at one of the following:
 - the preset time when the volume capacity falls below the reserve or the specified number of days between regenerations is reached whichever comes first; or
 - immediately after 10 minutes of no water usage when the volume capacity reaches 0 (zero).

DELAYED REGEN is the default if Step 4CS is set to ALTA or ALTB, and DELAY + IMMEDIATE REGENERATION will not be available.

IMMEDIATE REGENERATION is the default if Step 2CS is set to 1.0T, and “DELAY + IMMEDIATE REGENERATION will not be available.

This screen will not appear if OFF is selected in Step 9S.

See Setting Options Table for more detail. Press NEXT to go to Step 11S. Press REGEN to return to previous step.

STEP 11S

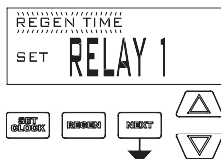

Step 11S: Set Relay 1 operation using ▲ or ▼. The choices are:

- Set REGEN TIME: Relay activates after a set time at the beginning of a regeneration and then deactivates after a set period of time. The start of regeneration is defined as the first backwash cycle or Regenerant Draw UP (1” only) or DN, whichever comes first.
- Set VOLUME: Relay activates after a set volume has been used while in service, then deactivates after the meter stops registering flow and the set time period has expired.
- Set REGEN VOLUME: Relay activates after a set volume has been used while in service or during regeneration, then deactivates after the meter stops registering flow and the set time period has expired.
- Set OFF: If set to Off, Steps 12S and 13S will not be shown.

Press NEXT to go to Step 12S. Press REGEN to return to previous step.

STEP 12S

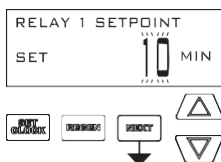

Step 12S: Set Relay 1 SETPOINT Time or Volume using ▲ or ▼. The choices are:

- Relay Actuation Time: After the start of a regeneration the amount of time that should pass prior to activating the relay. The start of regeneration is defined as the first backwash cycle or Regenerant Draw UP (1” only) or DN, whichever comes first. Ranges from 0 to 500 minutes.
- Relay Actuation Volume or Regen Volume: Relay activates after a set number of gallons have passed. Ranges from 1 to 20,000 gallons.
- Relay Actuation Hold Volume: The relay and related display activate after the set number of gallons have passed. The relay output and related display are reset when any button is pressed.

Press NEXT to go to Step 13S. Press REGEN to return to previous step.

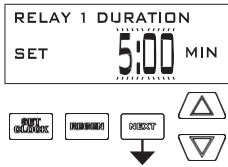
STEP 13S

Step 13S: Set Relay DURATION TIME using ▲ or ▼.

- If TIME is selected in Step 11S, the relay will deactivate after the time set has expired. Ranges from 0:01 to 500:00 minutes.
- If VOLUME or REGEN VOLUME is selected in Step 11S, the relay will deactivate after the time set has expired.

Press NEXT to go to Step 14S. Press REGEN to return to previous step.

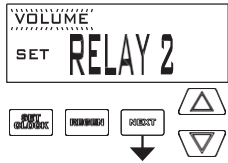
STEP 14S

Step 14S: Set Relay 2 operation using ▲ or ▼. The choices are the same as Step 11S, with the addition of ERROR MONITOR. If set to ERROR MONITOR, the relay closes whenever the valve enters error mode, and immediately deactivates when error mode is exited.

If set to OFF, Steps 15S and 16S will not be shown.

Press NEXT to go to Step 15S. Press REGEN to return to previous step.

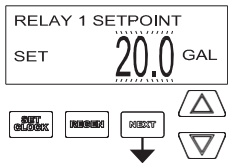
STEP 15S

Step 15S: Set Relay 2 SETPOINT Time or Volume using ▲ or ▼. The choices are the same as Step 12S.

Press NEXT to go to Step 16S. Press REGEN to return to previous step.

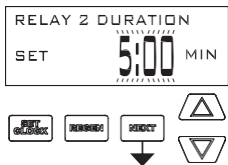
STEP 16S

Step 16S: Set Relay DURATION TIME using ▲ or ▼.

- If TIME is selected in Step 14S the relay will deactivate after the time set has expired.
- If VOLUME or REGEN VOLUME is selected in Step 14S the relay will deactivate after the time set has expired or after the meter stops registering flow, whichever comes first.

Press NEXT to go to Step 17. Press REGEN to return to previous step.

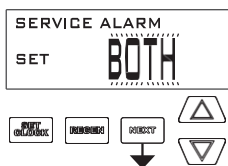
STEP 17S

Step 17S: Set scheduled service alarm using ▲ or ▼. Available options are OFF, TIME, GALLONS or BOTH. Selecting OFF disables this feature. If OFF is selected press NEXT to exit OEM Softener System Setup. If TIME, GALLONS or BOTH is selected press NEXT to select the TIME and/or GALLONS values. See Steps 18S and/or 19S. Press REGEN to return to the previous step.

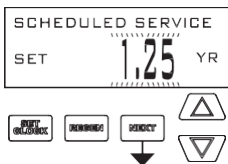
STEP 18S

Step 18S: Time remaining until Service Alarm generation. Only appears if TIME or BOTH is set in Step 17S. To change duration time, use ▲ or ▼ to select the new value. Press NEXT to exit OEM Softener System Setup or go to Step 19S if BOTH was selected in Step 17S. Press REGEN to return to the previous step.

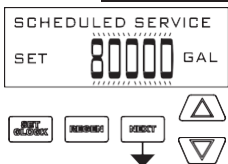
STEP 19S

Step 19S: Volume remaining until Service Alarm generation. Only appears if GALLONS or BOTH is set in Step 17S. To change the volume between service calls, use ▲ or ▼ to select the new value. Press NEXT to go to Step 20S. Press REGEN to return to the previous step.

STEP 20S



Step 20S: Status display only, if Step 17S is set to TIME or BOTH. Shows time remaining to Service Alarm. Can be reset to the initial value by pressing ▲ and ▼ for approximately 3 seconds. Press NEXT to exit OEM Softener System Setup or to go to Step 21S. Press REGEN to return to previous step.

STEP 21S

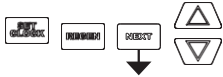

RETURN TO NORMAL MODE

Step 21S: Status display only, if Step 17S is set to TIME or BOTH. Shows time remaining to Service Alarm. Can be reset to the initial value by pressing ▲ and ▼ for approximately 3 seconds. Press NEXT to exit Softener System. Press REGEN to return to previous step.

Setting Options Table⁴

System Type	Regeneration Option	Regeneration Type	Day Override	
Softening	Auto	Normal	1-28 days	Regeneration occurs at the next regeneration time when volume capacity falls below the reserve capacity, or the specified number of days is reached, whichever comes first.
Softening	Auto	Normal	OFF	Regeneration occurs at the next regeneration time when volume capacity falls below the reserve capacity.
Softening or Filtering	20 – 1,500,000 Gallons	Normal	1-28 days	Regeneration occurs at the next regeneration time when volume capacity reaches 0, or the specified number of days is reached, whichever comes first.
Softening or Filtering	20 – 1,500,000 Gallons	Normal	OFF	Regeneration occurs at the next regeneration time when volume capacity reaches 0.
Softening or Filtering	OFF	Normal	1-28 days	Time Clock operation. Regeneration occurs at the next regeneration time the specified number of days is reached.
Softening	Auto or 20 – 1,500,000 Gallons	On 0	1-28 days	Regeneration occurs immediately when volume capacity reaches 0, or the specified number of days is reached, whichever comes first.
Softening or Filtering	20-1,500,000 Gallons	On 0	OFF	Regeneration occurs immediately when volume capacity reaches 0.
Softening	Auto	Normal + On 0	1-28 days	Regeneration occurs at the next regeneration time when volume capacity falls below the reserve capacity, or the specified number of days is reached, or regeneration occurs after 10 minutes of no water usage when volume capacity reaches 0.
Softening or Filtering	20 – 1,500,000 Gallons	Normal + On 0	1-28 days	Regeneration occurs at the next regeneration time the specified number of days is reached or regeneration occurs after 10 minutes of no water usage when volume capacity reaches 0.
Softening	Auto	Normal + On 0	OFF	Regeneration occurs at the next regeneration time when volume capacity falls below the reserve capacity, or regeneration occurs after 10 minutes of no water usage when volume capacity reaches 0.

⁴ Reserve capacity estimate is based on history of water usage. Reserve Capacity estimate is not available with alternator systems or Twin Tank Valve.

OEM Filter System Setup

Type	Backwash	Draw	Backwash	Rinse	Draw	Fill
Filtering DN Post	8	60	8	8		0.95 gal.
Filtering DN Post (2" valve)	8	60	8	8		6 min.

Cycle	Units	Range	Default
Backwash	MIN	1-120 or OFF	8
Rinse	MIN	1-120 or OFF	8
Draw (Up or Down)	MIN	1-160 or OFF	60
Fill (all but 2" valve)	GAL	0.05-20.00 or OFF	0.95
Fill (2" valve)	MIN	0.1-99.0 or OFF	6

STEP 1F

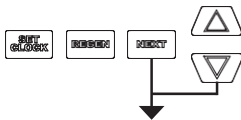

Step 1F – Press NEXT and ▼ simultaneously for 3 seconds and release. If screen in Step 2F does not appear in 5 seconds the lock on the valve is activated. To unlock press ▼, NEXT, ▲, and CLOCK in sequence, then press NEXT and ▼ simultaneously for 3 seconds and release.

STEP 2F

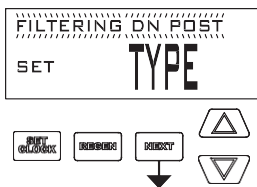

Step 2F – Choose FILTERING DN POST using ▼ or ▲. Press NEXT to go to Step 3F. Press REGEN to exit OEM Filter System Setup.

STEP 3F

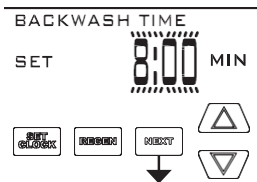

Step 3F – Select the time for the first cycle using ▼ or ▲. Press NEXT to go to Step 4F. Press REGEN to return to previous step.

STEP 4F

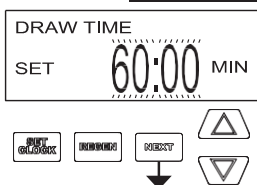

Step 4F – Select the time for the second cycle using ▼ or ▲. Press NEXT to go to Step 5F. Press REGEN to return to previous step.

STEP 5F

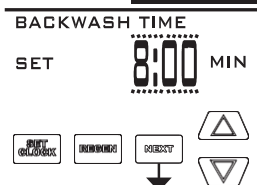

Step 5F – Select the time for the third cycle using ▼ or ▲. Press NEXT to go to Step 6F. Press REGEN to return to previous step.

STEP 6F

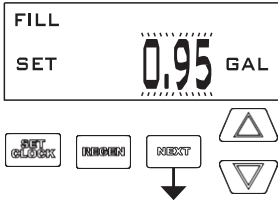

Step 6F – Select the time for the fourth cycle using ▼ or ▲. Press NEXT to go to Step 7F. Press REGEN to return to previous step.

STEP 7F

Step 7F – Select the gallons for the fifth cycle using ▼ or ▲. When 2.0 is selected in Step 2CS, FILL is in minutes. Press NEXT to go to Step 8F. Press REGEN to return to previous step.

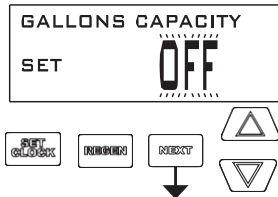
STEP 8F

Step 8F – Set Volume Capacity using ▲ or ▼. If value is set to:

- “OFF” regeneration will be based solely on the day override set (see Installer Display/Settings Step 3I); or
- a number, regeneration initiation will be based off the value specified.

See Setting Options Table for more detail. Press NEXT to go to Step 9F. Press REGEN to return to previous step.

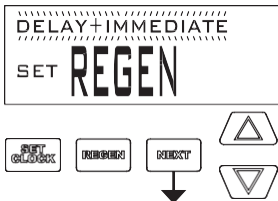
STEP 9F

Step 9F – Set Regeneration Time Options using ▲ or ▼. If “OFF” was selected in Step 7F, this screen will not appear.

If value is set to:

- DELAYED REGENERATION means regeneration will occur at the preset time;
 - IMMEDIATE REGENERATION means regeneration will occur immediately when the volume capacity reaches 0 (zero); or
 - DELAY + IMMEDIATE REGENERATION means regeneration will occur at one of the following:
 - the preset time when the volume capacity falls below the reserve or the specified number of days between regenerations is reached whichever comes first; or
 - immediately after 10 minutes of no water usage when the volume capacity reaches 0 (zero).
- DELAYED REGENERATION is the default if Step 4CS is set to ALTA or ALTB, and DELAY + IMMEDIATE REGENERATION will not be available.
 IMMEDIATE REGENERATION is the default if Step 2CS is set to 1.0T, and DELAY + IMMEDIATE REGENERATION will not be available.

See Setting Options Table for more detail. Press NEXT to go to the remaining Filter System Setup screens. Refer to Softener System Setup starting at Step 11S for details. Press REGEN to return to previous step.

Installer Display Settings

STEP 1I

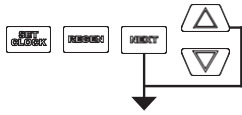

STEP 1I - Press NEXT and ▲ simultaneously for 3 seconds.

STEP 2I



STEP 2I – Hardness: Set the amount of hardness in grains of hardness as calcium carbonate per gallon using ▼ or ▲. The default is 20 with value ranges from 1 to 150 in 1 grain increments. Note: The grains per gallon can be increased if soluble iron needs to be reduced. This display will not appear if “FILTERING” is selected in Step 2F or if OFF or a number is set in Step 9S. Press NEXT to go to step 3I. Press REGEN to return to the previous step.

STEP 3I

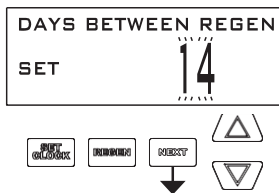

STEP 3I – Day Override: When volume capacity is set to “OFF”, sets the number of days between regenerations. When volume capacity is set to AUTO or to a number, sets the maximum number of days between regenerations. If value set to “OFF”, regeneration initiation is based solely on volume used. If value is set as a number (allowable range from 1 to 28) a regeneration initiation will be called for on that day even if sufficient volume of water were not used to call for a regeneration. Set Day Override using ▼ or ▲:

- number of days between regeneration (1 to 28); or
- “OFF”.

See Setting Options Table for more detail on setup. Press NEXT to go to step 4I. Press REGEN to return to previous step.

STEP 4I

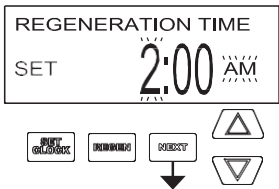

STEP 4I – Next Regeneration Time (hour): Set the hour of day for regeneration using ▼ or ▲. AM/PM toggles after 12. The default time is 2:00 AM. This display will not appear if IMMEDIATE is selected in Set Regeneration Time Option in OEM Softener System Setup Step 10S. Press NEXT to go to step 5I. Press REGEN to return to previous step.

STEP 5I

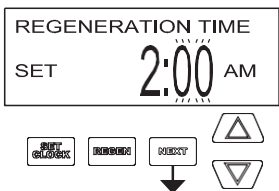

STEP 5I – Next Regeneration Time (minutes): Set the minutes of day for regeneration using ▼ or ▲. This display will not be shown if IMMEDIATE is selected in Set Regeneration Time Option in OEM Softener System Setup Step 10S. Press NEXT to go to Step 6I. Press REGEN to return to previous step.

STEP 6I

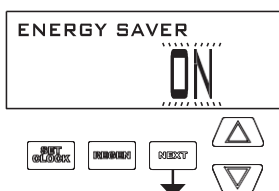

STEP 6I – As an energy-saving feature, the control will automatically turn off the display illumination after 5 minutes of keypad inactivity. Any further keypad activity or water use will re-illuminate the display for 5 minutes. The Energy Saver feature default is ON. Press NEXT to exit Installer Display Settings. Press REGEN to return to previous step.

RETURN TO NORMAL MODE

User Display Settings

General Operation

When the system is operating, one of several displays may be shown. The displays normally rotate, however pressing NEXT will pause on the selected display for 5 minutes. Pressing NEXT will alternate between the displays. One of the displays is always the current time of day. Days Remaining is the number of days left before the system goes through a regeneration cycle. Gallons Remaining is the gallons that will be treated before the system goes through a regeneration cycle. Pressing ▼ while in the Gallons Remaining display will decrease the capacity remaining in 10 gallon increments and will also increase the volume used impacting the recorded values in Diagnostics Steps 3D, 4D and 5D and Valve History, Step 4VH. Another display shows the current treated water flow rate through the system. Either REGENERATION DP or REGENERATION HOLD will be displayed if the dP switch is closed. To clear the Service Call reminder, press ▲ and ▼ simultaneously while the number and banner text screen is displayed.

If the system has called for a regeneration that will occur at the preset time of regeneration, the words REGEN TODAY will alternate with the header on the display.

If a water meter is installed, the flow indicator flashes on the display when water is being treated (i.e. water is flowing through the system).

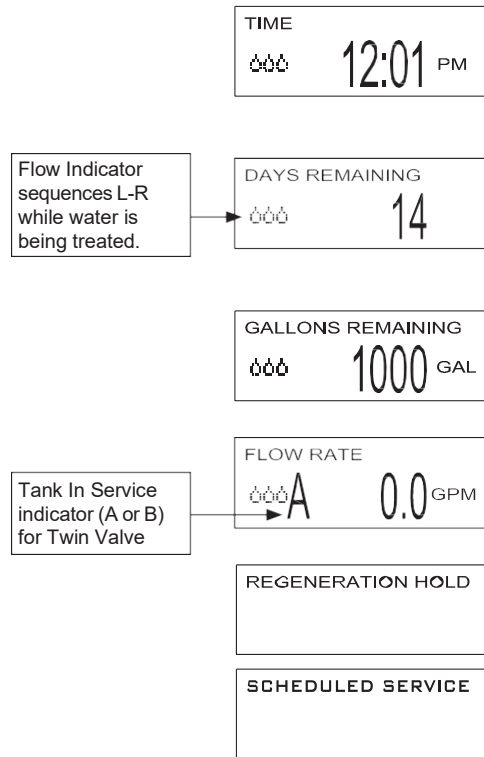

REGEN PENDING will be displayed in Alternator Systems whenever a unit is waiting to initiate the first cycle step of regeneration. The name of an active MAV will also be indicated in this display.



STAND BY will be displayed in Alternator Systems when a valve is in Standby state. The name of an active MAV will also be indicated in this display.



DELAYED RINSE+FILL PENDING will be displayed whenever a zero-capacity tank has transferred to an off-line state and is currently waiting to initiate the second portion of a regeneration cycle. Viewed only when Delayed Rinse and Fill is set to ON.



Regeneration Mode

Typically a system is set to regenerate at a time of low water usage. An example of a time with low water usage is when a household is asleep. If there is a demand for water when the system is regenerating, untreated water will be used.

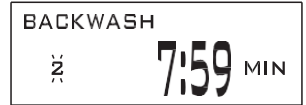

When the system begins to regenerate, the display will change to include information about the step of the regeneration process and the time remaining for that step to be completed. The system runs through the steps automatically and will reset itself to provide treated water when the regeneration has been completed.

Manual Regeneration

Sometimes there is a need to regenerate the system sooner than when the system calls for it, usually referred to as manual regeneration. There may be a period of heavy water usage because of guests or a heavy laundry day.

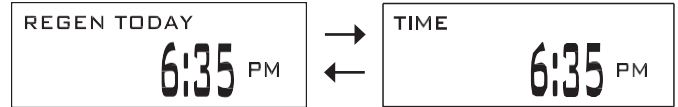

To initiate a manual regeneration at the preset delayed regeneration time, when the regeneration time option is set to DELAYED REGENERATION or DELAY + IMMEDIATE REGENERATION, press and release REGEN. The words REGEN TODAY will periodically be shown on the display to indicate that the system will regenerate at the preset delayed regeneration time. If you pressed the REGEN button in error, pressing the button again will cancel the request. Note: If the regeneration time option is set to IMMEDIATE REGENERATION there is no set delayed regeneration time so REGEN TODAY will not activate if REGEN is pressed.

To initiate a manual regeneration immediately, press and hold the REGEN button for three seconds. The system will begin to regenerate immediately. The request cannot be cancelled.

Note: For softeners, if brine tank does not contain salt, fill with salt and wait at least two hours before regenerating.

Set Time of Day

The user can also set the time of day. Time of day should only need to be set if the battery has been depleted because of extended power outages or when daylight saving time begins or ends. If an extended power outage occurs, the time of day will flash on and off which indicates the time of day should be reset. The non rechargeable battery should also be replaced.

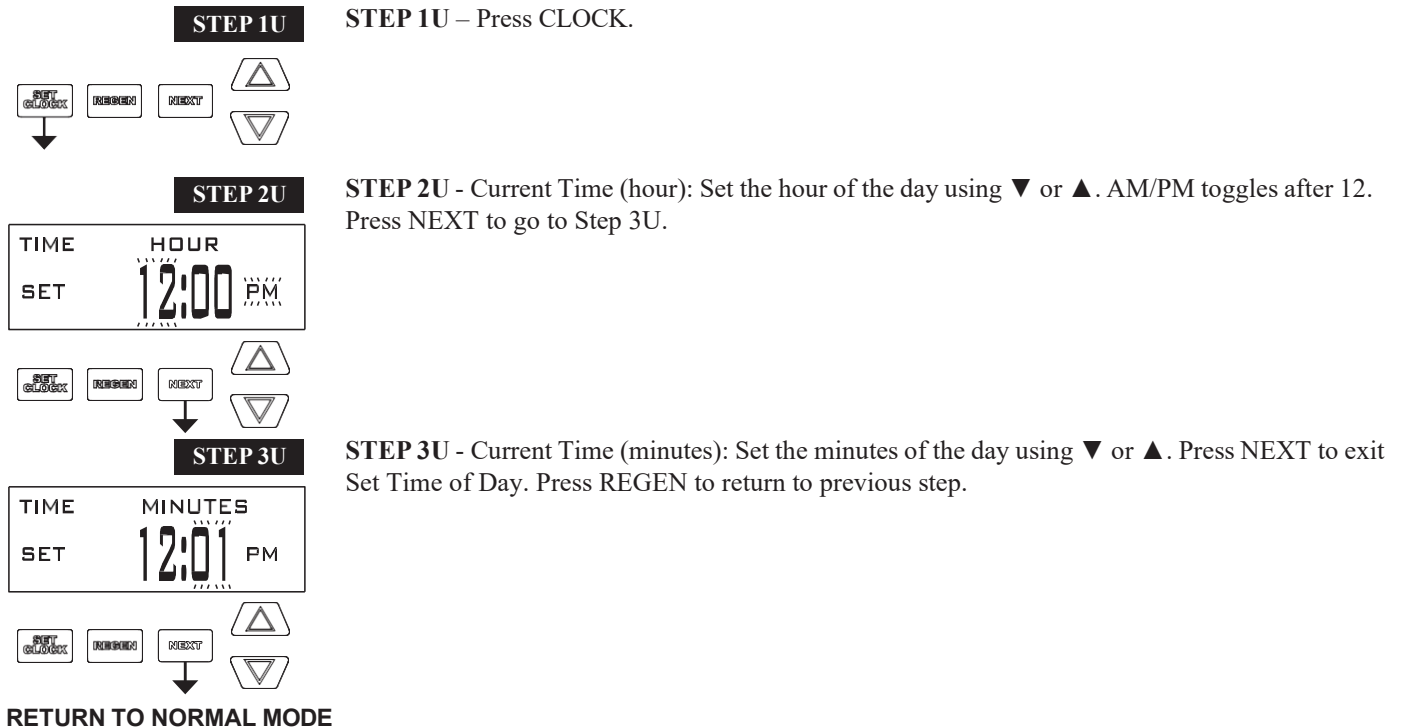

Power Loss

If the power goes out the system will keep time until the battery is depleted. If an extended power outage occurs, the time of day will flash on and off which indicates the time of day should be reset and the non rechargeable battery replaced. The system will remember the rest.

Error Message

If the word "ERROR" and a number are displayed contact the OEM for help. This indicates that the valve was not able to function properly. If the number and banner text in the Contact Screens has been edited, the two displays below will alternate.

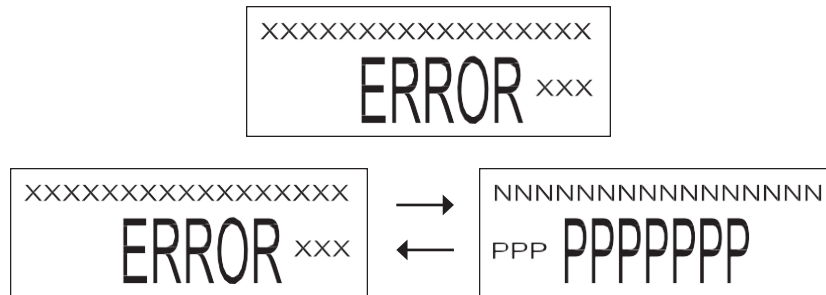

Diagnostics

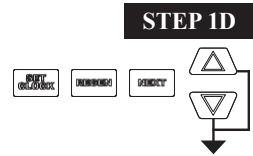

STEP 1D – Press ▲ and ▼ simultaneously for three seconds. If screen in step 2D does not appear in 5 seconds the lock on the valve is activated. To unlock press ▼, NEXT, ▲, and CLOCK in sequence, then press ▲ and ▼ simultaneously for 3 seconds.

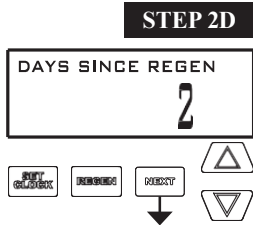

STEP 2D – Days, since last regeneration: This display shows the days since the last regeneration occurred. Press NEXT to go to Step 3D. Press REGEN to exit Diagnostics.

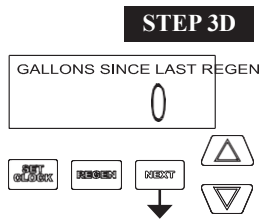

STEP 3D – Volume, since last regeneration: This display shows the volume of water that has been treated since the last regeneration. This display will equal zero if a water meter is not installed. Press NEXT to go to Step 4D. Press REGEN to return to previous step.

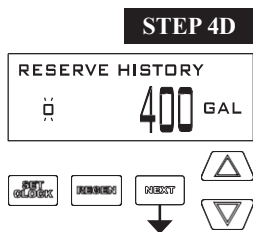

STEP 4D – Reserve History Volume used for last 7 days: If the valve is set up as a softener, a meter is installed and Set Volume Capacity is set to “Auto,” this display shows 0 day (for today) and the reserve capacity. Pressing ▲ will show day 1 (which would be yesterday) and the reserve capacity used. Pressing ▲ again will show day 2 (the day before yesterday) and the reserve capacity. Keep pressing ▲ to show the capacity for days 3, 4, 5 and 6. ▼ can be pressed to move backwards in the day series. This screen is not displayed if filter, time clock, meter immediate, alternator or volume override regeneration is selected. Press NEXT at any time to go to Step 5D. Press REGEN to return to previous step.

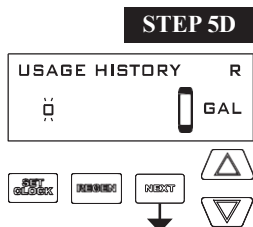

STEP 5D - Volume, 63-day usage history: This display shows day 0 (for today), day 1 (for yesterday), etc., and the volume of water treated that day. Press ▲ to show the volume of water treated for the last 63 days. If a regeneration occurred on the day the letter “R” will also be displayed. This display will show dashes if a water meter is not installed. Press NEXT at any time to go to Step 6D. Press REGEN to return to previous step.

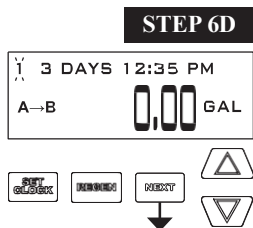

STEP 6D - Tank Transfer History. Only displayed when 1.0T is selected in Step 2CS. Use ▲ or ▼ to scroll through the last 10 tank transfers. “1”= transfer number – 10 transfers maximum. “A” = tank transferring. “3 DAYS” = days ago of transfer – 99 days maximum. “0.00 GAL” = gallons used at time of tank transfer. “12:35 PM” = time of transfer. Press NEXT to go to Step 7D. Press REGEN to return to previous step.

STEP 7D

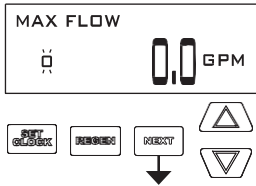

STEP 7D – Flow rate, maximum last seven days: Use ▲ or ▼ to display the maximum flow rate in gallons per minute that occurred in each of the last seven days. This display will equal zero if a water meter is not installed. Press NEXT to go to Step 8D. Press REGEN to return to previous step.

STEP 8D

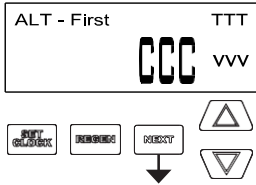

STEP 8D – MAV Drive History: Displays the drive time histories of all active MAV drives. Use ▲ or ▼ to review the history of all active MAV outputs. TTT – measured MAV drive time; VVV – measured MAV drive voltage; CCC – total number of drives (in or out); “+” indicates piston drive out of MAV; “-“ indicates piston drive in to MAV. If a MAV is replaced, it is recommended that the diagnostics screen for that MAV be cleared. That is done by selecting the + or – screen for that MAV. Press and hold ▲ and ▼ for about 3 seconds. Failure to do this may result in inconsistent MAV operation.

RETURN TO NORMAL MODE

When a MAV error occurs, the Drive History will automatically be reset. To view previously recorded history, press and hold CLOCK and ▲. The display will be similar to the normal MAV drive history display, with the addition of EEE – MAV error code present at the time of reset. If the display shows “---”, there was no MAV error before the reset.



Press NEXT to exit Diagnostics. Press REGEN to return to previous step.

When desired, all programming and information in Diagnostics may be reset to defaults when the valve is installed in a new location. To reset to defaults, press NEXT and ▼ simultaneously to go to the Softening/Filtering screen. Press ▲ and ▼ simultaneously to reset programming and diagnostic values to defaults. Screen will return to User Display.

Valve History

STEP 1VH

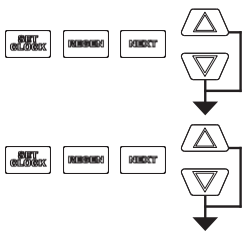

STEP 1VH – Press ▲ and ▼ simultaneously for three seconds and release. Then press ▲ and ▼ simultaneously and release. If screen in step 2VH does not appear in 5 seconds the lock on the valve is activated. To unlock press ▼, NEXT, ▲, and CLOCK in sequence, then press ▲ and ▼ simultaneously for 3 seconds and release. Then press ▲ and ▼ simultaneously and release.

STEP 2VH

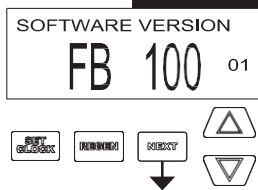

STEP 2VH – Software version. Displays the current software version. Press NEXT to go to Step 3VH. Press REGEN to exit Valve History.

STEP 3VH

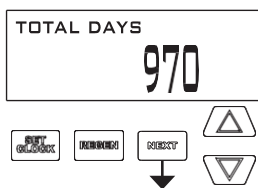

STEP 3VH⁵ – Days, total since start-up: This display shows the total days since startup. Press NEXT to go to Step 4VH. Press REGEN to return to previous step.

STEP 4VH

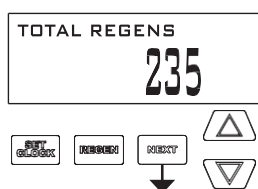

STEP 4VH – Regenerations, total number since start-up: This display shows the total number of regenerations that have occurred since startup. Press NEXT to go to Step 5VH. Press REGEN to return to previous step.

STEP 5VH

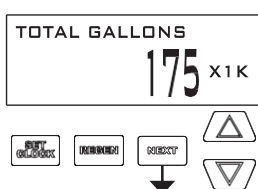

STEP 5VH – Volume, total used since start-up: This display shows the total gallons treated since startup. This display will equal zero if a water meter is not installed. Press NEXT to go to Step 6VH. Press REGEN to return to previous step.

STEP 6VH

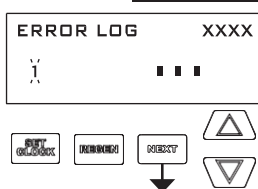

STEP 6VH – Error Log. This display shows a history of the last 10 errors generated by the control during operation. The motor position count at the time of drive error detection is recorded in the top line of the display. Press ▲ or ▼ to view each error recorded. Press NEXT to exit Valve History. Press REGEN to return to previous step.

RETURN TO NORMAL MODE

⁵ Values in steps 2VH through 5VH cannot be reset.

Water Treatment System Warranty

This quality FRAKCO water softener is designed and built to provide many years of satisfactory performance under normal use. FRAKCO, INC. pledges to the original owner that for sixty months, all non-wearable items of the above-described water treatment system proven to be defective due to workmanship and/or materials will be replaced or repaired. FRAKCO also pledges that the fiberglass media tank is covered under this warranty for ten years if owned by the original purchaser. Out pledge does not apply if the damage is caused by defective installation; water pressure in excess of eighty pounds per square inch; water temperature in excess of 110° F.; misuse; unauthorized alterations; freezing; accident; fire; neglect; or damage caused by shipping.

To obtain service under this warranty, notify FRAKCO, INC in writing of any defects in workmanship within thirty days of the appearance of such defects. Such written notice must include the date of purchase, the part number, and a description of the defect. Upon receiving such notice and determining that the defect is covered by this warranty, FRAKCO, INC. will replace or repair the defective item. Replacement of a defective item will be at FRAKCO'S factory in Luverne, MN, and the purchaser must ship the defective item at its own expense to FRAKCO'S factory. Replacement items will be shipped by FRAKCO F.O.B. Luverne, Minnesota, with a shipping carton furnished. In the event certain models or colors of the replacement item are out of stock, FRAKCO, INC. may, after notifying the purchaser, furnish another model or color of the replacement item. The factory will not pay for service charges and will not perform any repair or service functions other than at its home office.

Please follow the enclosed instructions and local codes in installing your water treatment system. Failure to do so will void this warranty. Nothing in the warranty may be construed as involving the factory in the relationship between Dealer and Owner.

This warranty gives the purchaser specific legal rights. The purchase may also have implied warranty rights. In the event of a problem with warranty service or performance, the purchaser may be able to go to a Small Claims Court, a State Court, or a Federal District Court. This warranty complies with the 1975 Federal Warranty Law.

Model No. _____ Serial No. _____ Date Installed _____
Dealer _____ Address _____

*MANUFACTURED BY: FRAKCO, INC.
500 N BLUE MOUND AVE
LIVERNE, MINNESOTA 56156
WWW.FRAKCO.COM*