



AQUA MAGIC

WARDENPRO

Residential Reverse Osmosis System Installation, Operation, & Maintenance Manual Aqua Magic Warden Pro LP *With 50 GPD Membrane*



Model: _____

Serial Number: _____

Install Date: _____

Installed By: _____

Service Phone: _____

Sold By: _____

Please read this manual carefully before proceeding with installation. Your failure to follow any of these instructions or operating parameters, may lead to personal injury or damage to the equipment and/or personal property. Do not use this RO system with water that is microbiologically unsafe or of unknown quality, without adequate disinfection before or after the system. This RO system contains replaceable treatment components critical for effective performance. It is the user's responsibility to periodically test the product water to verify the system is performing satisfactorily. Failure to properly maintain this RO system may cause a health risk.

Save this manual for future reference

Table of Contents

Section 1: Introduction	3
Section 2: Important Background Information.....	4
What is Reverse Osmosis (RO).....	4
How the Aqua Magic RO System is Different.....	4
Importance of Pre-Filtration	4
Booster Pump Technology	4
Tank Pressure Shut-Off Switch Technology	5
Automatic Shut-Off Technology.....	5
Factors That Affect System Performance	5
How to Make a Proper Quick Connect Tubing Connection	6
Section 3: System Specifications.....	7
Design Specifications.....	7
System Parameters	7
Section 4: Getting to Know Your System	8
Section 5: Under-the-Counter Flow Diagram	9
Section 6: Installation Instructions.....	9
What's Included	10
What You'll Need	10
Step 1: Select an Installation Site.....	11
Step 2: Faucet Installation.....	12
Step 3: Install Valve to Feed Water Supply	13
Step 4: Install the Drain Saddle Clamp	15
Step 5: Install the Tank Shut-Off Valve	15
Step 6: Install the Filter Cartridges	16
Step 7: Mount RO System.....	16
Step 8: Make Tubing Connections.....	16
Feed Water Connection (WHITE Plug).....	17
Drain/Reject Water Connection (RED Plug).....	17
Storage Tank Water Connection (YELLOW Plug).....	18
Faucet Connection (BLUE Plug)	18
Step 9: Connect Booster Pump Transformer	19
Step 10: Ice Maker Connection (Optional)	20
Step 11: Record Information in a System Maintenance & Repair Log.....	20
APPENDIX: Basement Installations	21
Faucet Installation	21
Install the Drain Saddle Clamp.....	21
Mount RO System	21
Make Tubing Connections	22
Section 7: Start-Up Procedure	23
Section 8: Maintenance Procedures	24
Filter Cartridge and RO Membrane Replacement	24
Replacing Filter Cartridges	24
Changing the RO Membrane.....	25
Sanitizing the RO System and Storage Tank.....	25
Section 9: RO Service Record Information	27
Booster Pump Troubleshooting.....	30
Section 11: Product Warranty.....	31
Section 12: Replacement Parts List	32

Section 1: Introduction

Thank you for choosing this Reverse Osmosis Drinking Water System! Every Aqua Magic RO System incorporates years of experienced engineering, dedicated workmanship, and high-quality components. Each system is built with pride and ensures superior performance. We are confident you will find this system to have quick and simple installation, hassle-free maintenance, and years of reliable, trouble-free operation.

Proper installation and maintenance of your new RO System is very important. Please read and follow this instruction manual carefully before attempting installation. Failure to do so could result in personal injury or damage to the equipment and/or personal property. As with all products, the customer has the responsibility to ensure that the RO System is operated under proper conditions and within design limitations.

IMPORTANT: Improperly installed systems could result in water damage due to leaks or flooding. System installation must also always comply with local and state laws and regulations. Proper installation of this system requires familiarity with state and local codes, standard sink plumbing, and proper use of the necessary tools. If you are not familiar with any of these, or have difficulty with the installation of this system, please contact an experienced water treatment professional to perform the installation.

Section 2: Important Background Information

What is Reverse Osmosis (RO)

In the reverse osmosis process, water is forced under pressure through a semi-permeable membrane to reduce the dissolved mineral content of the water. The membrane allows water molecules to pass through, but blocks/hinders the passage of dissolved substances and suspended particles. This process reduces the levels of dissolved salts, minerals, and suspended particles, while improving the taste, odor, and clarity of the water.

Certain contaminants found in water are measured as Total Dissolved Solids (TDS). Unlike the more common standard filtration systems, reverse osmosis systems divide the feed water into two streams: product water (“permeate”) and drain/reject water (“concentrate”).

The product water is the desired outcome of the RO system – much cleaner and fresher tasting water! The drain/reject water is vital for carrying away the dissolved salts, minerals, and suspended particles. Unlike conventional filtration systems, the majority of contaminants removed from your water are not held onto within the system, but instead flushed away.

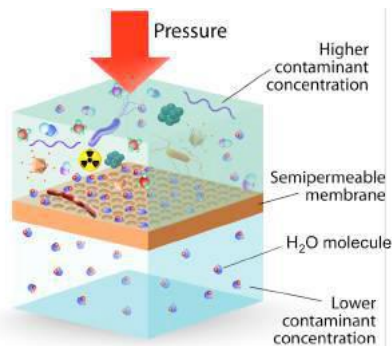

How the Aqua Magic RO System is Different

Your new RO system uses a combination of filtration technologies to reduce unwanted contaminants in a water supply. Every RO system is engineered for the utmost reliability and convenience. That's why each system incorporates the advanced technology of encapsulated membranes. Encapsulated membranes combine the membrane vessel and RO membrane, all inside a single compact module. No more hassle of handling the raw membrane elements! Forget the fuss of unscrewing tightened membrane vessels at every replacement! Servicing and maintenance is simplified and faster with this streamlined process. For more information on your unique model, please refer to the “Getting to Know Your System” section to better understand the different stages that work together in making your RO system great!

Importance of Pre-Filtration

Pre-treatment in an RO System is crucial. By running the feed water through the appropriate pre-filter, the RO membrane is protected against permanent damage and premature fouling. The filter cartridges in this system must be replaced on a regular basis to maintain efficiency and to ensure high water quality. Any significant change in performance of the system should be investigated promptly to avoid secondary damage, deterioration to parts of the system, or hindered quality of the drinking water.

Booster Pump Technology

Feed water conditions vary with every installation. In some cases, the feed water supply might have higher than normal TDS, low inlet pressure, or even atypical cold water temperature. In order to meet the demands of your application, sometimes you just need an extra boost!

The Aqua Magic Warden Pro LP RO System combines its trusted RO design with the latest booster pump technology, providing a reliable increase to the inlet pressure. This increase in feed pressure improves the efficiency of your RO membrane – boosting the performance and production!

Tank Pressure Shut-Off Switch Technology

While the booster pump is fully capable of constant use, it's inefficient to run the pump when it's not needed. That's why every Aqua Magic Low Pressure RO System also incorporates the technology of an inline tank pressure switch. The switch is installed on the storage tank line of the RO system, and automatically triggers the booster pump to shut off when the storage tank is full. Subsequently, the tank pressure switch will also trigger the booster pump to turn back on when it senses the storage tank is near empty. This technology allows your RO system to be more efficient, extend the life of your booster pump, and adapt to changing usages. All while saving you money!

Automatic Shut-Off Technology

Every RO system comes equipped with an automatic shut-off valve. This component closes when it senses that the storage tank is full – immediately shutting off the water supply. As a result, the production of water is paused, and excess reject water is prevented from draining.

Factors That Affect System Performance

Feed Water Temperature: The ideal water temperature for a RO system is 77°F. The quantity of product water produced increases with higher water temperatures, and decreases with lower water temperatures. Temperatures below 40°F can damage the membrane, and temperatures above 90°F can cause rapid deterioration of the membrane.

Feed Water Pressure: The greater the water pressure, the better water quantity and quality the system will produce. Water pressure of 60 psi is ideal. (Maximum 90 psi; Minimum 40 psi)

Total Dissolved Solids (TDS): The higher the amount of dissolved contaminants in the feed water, the lower the quantity of water produced. A high level of TDS can be overcome with a booster pump.

Bacteria: When RO systems are used, tested, or operated intermittently, they may be exposed to bacteria. Following a shut down or storage period, the RO system and storage tank should be sanitized.

Fouling or Surface Coating of the Membrane: Membrane fouling is a common problem resulting from salts, hardness, iron, etc. collecting on the membrane surface. The pores and channels of the membrane become plugged, reducing the water production rate. Pre-treatment equipment, such as a water softener, iron filter, and/or turbidity filter, will reduce membrane fouling and extend its life.

How to Make a Proper Quick Connect Tubing Connection

Your RO System has been designed with the most reliable fittings available. It is important that the manufacturer's instructions are followed carefully to ensure a leak-free connection.

Be sure to cut tubing end straight and square. The cut end must be free of burrs and sharp edges. For soft thin walled plastic tubing, we recommend the use of a tube insert.

1 Insert tube

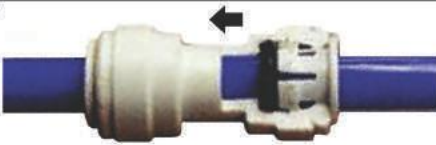

Fitting grips before it seals. Ensure tube is pushed into the tube stop.

2 Push up tube to stop



Push the tube into the fitting to the tube stop. The collet (gripper) has stainless steel teeth which hold the tube firmly in position while the o-ring provides a permanent leak proof seal.

3 Pull to check secure



Pull on the tube to check that it is secure. It is a good practice to test the system prior to leaving the site and before use.

4 Disconnecting - Push collet and remove tube



To disconnect, ensure the system is depressurized before removing the tube. Push in collet squarely against face of fitting. With the collet held in this position, the tube can be removed. The fitting can then be re-used.

Section 3: System Specifications

Design Specifications

Production Rate:	GRO-50EN – 50 GPD*
Rejection Rate (NaCl):	96%
Recovery:	50%
Feed Pressure:	65 psi
Feed Temperature:	77°F (24°C)

**Actual system production may vary depending on incoming water temperature and chemistry.*

Nominal performances are based on the above Design Specifications, after 25 hours

Individual element flux may vary +/- 15%.

System Parameters

Temperature:	Max 90°F (37.8°C), Min 40°F (4.4°C)
Pressure:	Max 100 psi, Min 45 psi
Iron:	Max 0.5 ppm
Hardness:	Max 10 gpg, or 170 mg/l
Chlorine:	Must be removed prior to contact with the RO membrane to prevent permanent damage. This is the purpose of carbon pre-filters.
Total Dissolved Solids (TDS):	Max 1,800 ppm
Turbidity:	Less than 5 NTU
pH:	3.0-11.0 (optimum rejection at 7.0 – 7.5)
Manganese:	Max 0.05 ppm
Hydrogen Sulfide:	0.00
Bacteria:	Feed water must be potable.

Note: The water pressure in your home should be tested over a 24-hour period to attain an accurate pressure reading. If the water pressure exceeds 85 psi, a pressure regulator may be required. If the water pressure falls below 45 psi, a booster pump may be required. A feed water pressure below 45 psi will severely lower the efficiency of your RO system, and may inhibit the automatic shutoff from properly closing.

Note: The system will operate with hardness over 10 grains, but the RO membrane life may be shortened. The addition of a water softener will extend the life of the RO membrane.

IMPORTANT: Do not use this system with water that is microbiologically unsafe or of unknown quality without adequate disinfection before or after the system.

Section 4: Getting to Know Your System

It is important to familiarize yourself with your new Reverse Osmosis System.

Shown below is a front and back view of the system, with the stages and main components identified. These components will be referenced throughout the manual. Noting their location will assist you with the installation and maintenance of the RO system.

Top View

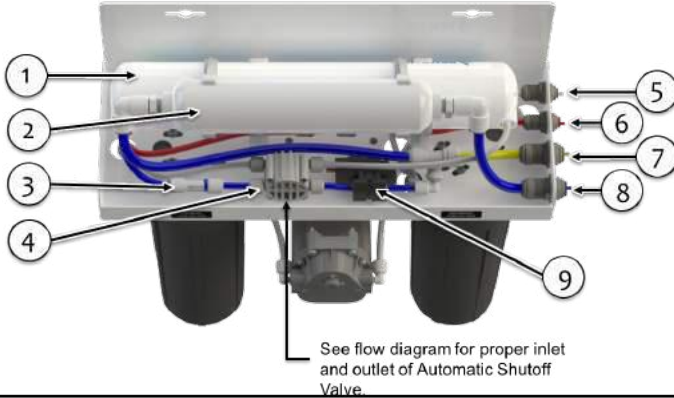

Front Angle View

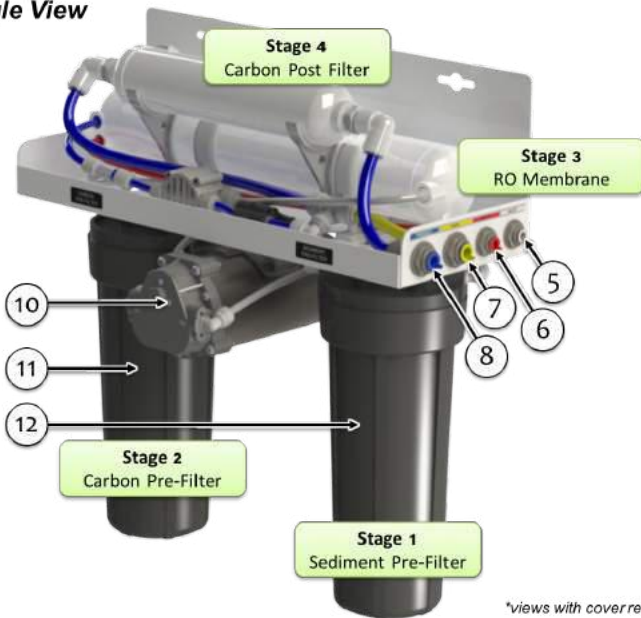

- 1) RO Membrane
- 2) Carbon Post Filter
- 3) Product Water Check Valve
- 4) Automatic Shutoff Valve
- 5) Feed Water Inlet (1/4" White Plug/Tubing)
- 6) Drain/Reject Outlet (1/4" Red Plug/Tubing)

- 7) Storage Tank Outlet (3/8" Yellow Plug/Tubing)
- 8) Product Water Outlet (3/8" Blue Plug/Tubing)
- 9) Tank Pressure Pump Shutoff Switch
- 10) High Flow Booster Pump
- 11) Carbon Pre-Filter
- 12) Sediment Pre-Filter Housing

Section 5: Under-the-Counter Flow Diagram

Provided below is a detailed flow diagram for the Aqua Magic Warden Pro RO System. Please take the time to familiarize yourself with the placement of major components and the correct flow of water through them. Understanding this will be very important for the installation and maintenance of your RO system. It is also recommended to reference this diagram again when making your tubing connections. This will ensure proper identification and placement of connections.

Note: See APPENDIX of Section 6: Installation Instructions for a Basement Flow Diagram

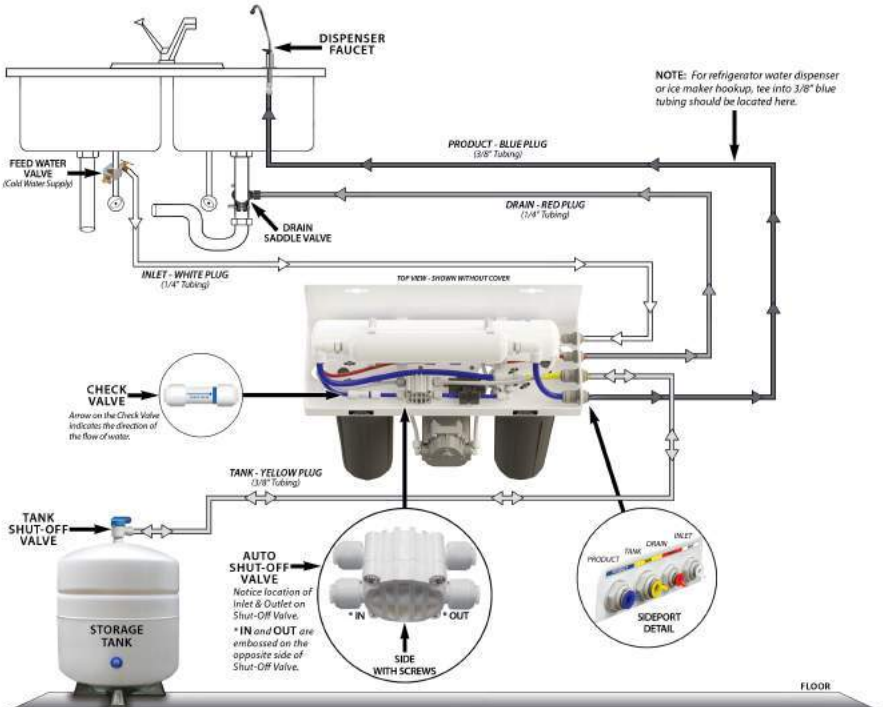



















NOTE: If air gap in faucet is not used, a proper air gap must be created or air gap device installed. Please check with local plumbing codes for more information.



Section 6: Installation Instructions

What's Included

MAJOR COMPONENTS					
	AM Warden Pro LP 4-Stage RO System		Dispenser Faucet		Storage Tank
	Sediment Filter Cartridge Qty: 1		Carbon Filter Cartridge Qty: 1		Booster Pump Transformer

PARTS PACKET							
	Tank Shut-Off Valve		Faucet Connector		Filter Housing Wrench		3/8" & 1/4" Tube Inserts
	Mur-lok® RO-Pal Connector (Standard)		Drain Saddle Clamp		1/4" and 3/8" Red Tubing		3/8" Blue Tubing
	John Guest® Angle Stop Adapter Valve (Optional)		Self-Piercing Saddle Valve (Optional)		3/8" Yellow Tubing		1/4" White Tubing

What You'll Need

- ✓ Extension work-light
- ✓ Battery operated drill and drill bits
- ✓ 1-1/4" Hole saw bit/punch for faucet
- ✓ Screw Drivers (Phillips & flathead)
- ✓ Pliers (needle nose & adjustable)
- ✓ Utility Knife
- ✓ Tubing Cutter
- ✓ Teflon Tape
- ✓ Safety Glasses
- ✓ Food Grade Lubricant
- ✓ TDS Test Meter

NOTE: If an air gap faucet is not used, reject water must go to drain through an anti-siphon air gap. Please check local plumbing codes.

Step 1: Select an Installation Site

This RO system was designed compact enough to fit under most kitchen sinks. However, the RO system may easily be installed in a basement, closet, crawl space, or wherever it's most convenient. If a basement installation is selected, note that additional tubing, hardware, and fittings may be needed, and that a hole will have to be made from inside the cabinet through the floor to the basement.

When determining the best location to mount the RO system, there must be access to a cold water line and a drain line. Never install in an area of the home where temperature is freezing as it may result in damage to the system. The water storage tank may weigh up to 30 pounds when full of water. Be sure to place it on a firm, level surface.

The exact placement of the RO system and its accessories will vary with each installation. The installer and customer must coordinate together on determining the most convenient placement of the dispenser faucet, RO system, and storage tank.

Always consider easy maintenance and servicing when choosing an installation site. It's recommended to mount the RO system at least 4" off the ground. This will allow ample room to remove the filter housings. However, if the mounting wall is not solid, the system may sit on the floor with screws used to keep it against the cabinet/wall in a vertical position.

Consideration for an ice maker or additional connections should also be made at this time. Extra routing, tools, fittings, and tubing may be required.

IMPORTANT: For basement installations, please see the **APPENDIX** at the end of this section for additional information.

Step 2: Faucet Installation

When selecting a location for your faucet, be sure the stem of the faucet will be accessible for making all connections. Always take special care and consideration if drilling a new hole for a faucet. We cannot accept any responsibility for damage to sinks or countertops when you are drilling a hole for your dispenser faucet. The following are only guidelines to aid with the installation for your dispenser faucet.

Under the counter installations generally require that the faucet be installed with the air gap module. In basement installations, the air gap module can be eliminated only if one is provided elsewhere in the drain line.

NOTE: The Uniform Plumbing Code dictates that there must be an air gap between the RO line and the waste drain. It is the responsibility of the installer to ensure compliance with all State and Local laws and regulations

IMPORTANT: For basement installations, please see the **APPENDIX** at the end of this section for additional information.

Drill Hole for Faucet

Most sinks are predrilled with a hole that's commonly used for a sprayer or soap dispenser. This could be used for an RO faucet instead, with no need to drill a new one. However, if your installation site does not have a properly sized hole, or it's already being used, an additional hole will need to be drilled. Always check below the sink to make sure nothing will interfere when drilling, and that a 2" flat surface is available on your sink for mounting the faucet. The faucet should be aesthetically located, positioned to flow directly into the sink, and be able to swivel freely for convenience.

Drilling a Stainless Steel Sink

The faucet opening should be centered between the back splash and the edge of the sink, ideally on the same side as the vertical drainpipe.

- 1) Mark the center, and drill a 1/4" pilot hole.
- 2) Continue to enlarge hole with increasingly larger drill bits until the hole is 1/2" in diameter.

Note: Air Gap Faucets require a 1-1/4" hole. If installing an Air Gap Faucet, use a 1-1/4" Greenlee hole punch to create the larger hole.

- 3) Smooth any rough edges and sweep away chips.

Drilling a Porcelain Sink

Porcelain sinks are extremely hard and can crack or chip easily. Always use proper tools and extreme caution when drilling.

- 1) Place a piece of masking tape over the area to be drilled to help avoid chipping.
- 2) Mark the center of the hole on the tape.
- 3) Drill a pilot hole using 1/4" carbide tipped pilot drill bit.
- 4) Drill at a slow speed to avoid cracking and chipping.
- 5) Using a porcelain cutter, drill out 1/2" hole. Keep the drill speed on the slowest speed, and use lubricating oil to keep the drill bit cool.

Note: Air Gap Faucets require a 1-1/4" hole. If installing an Air Gap Faucet use specialized 1-1/4" cutter designed for porcelain.

- 6) Remove all sharp edges with a file.
- 7) Make sure the surroundings of the sink are cooled before mounting the faucet.

Mount the Faucet

- 1) Slide the 1-1/4" faceplate, rubber washer, and the 1-7/8" rubber gasket onto the faucet stem.
- 2) Place the stud through the hole in the sink or counter top, and properly position the faucet.
- 3) From under the counter, slide on the black plastic washer and the metal star washer, and screw on the faucet lock nut (these parts are included with faucet).
- 4) Tighten securely.
- 5) At the bottom of the faucet stem, securely tighten the John Guest® faucet connector (provided in the Parts Packet with your system).

Note: Any remaining faucet parts are replaced by the John Guest® faucet connector and can be discarded.



Step 3: Install Valve to Feed Water Supply

Locate the cold water supply shut-off valve, and turn it off. Open the cold water sink faucet to release any water and pressure. On single handled faucets, the hot water may have to be turned off to prevent any hot water crossover. If water continues to come out of the faucet, with the valve turned off, the main house line may need to be turned off.

The following instructions describe the installation of three different types of valves that can be used on a feed water supply line. Please take note of which valve you are using, follow those instructions carefully, and skip the step details for the other valve options.

CAUTION: Do not connect the feed water valve to the hot water pipe. Hot water will severely damage your RO membrane. The connection must be made with the cold water line.

If Using Mur-lok® RO-Pal Connector (*Standard – Included with every Aqua Magic System*)



The Mur-lok® RO-Pal Feed Water Connector is a reliable choice for rigid piping. It works great with copper, chrome, CPVS, and PEX tubing. Easy installation in five minutes or less, and has an all plastic design to eliminate corrosion.

- 1) Be sure the water supply is off.
- 2) Ensure the pipe or tubing is RIGID.
- 3) Identify a smooth, even surface, and cut a section of pipe where the RO-Pal will be installed.
- 4) Remove all burrs from pipe using a sandcloth.

IMPORTANT: Do not use any sealants or Teflon tape on any of the RO-Pal's fittings.

- 5) Slide narrow end of nut onto pipe, inside threaded end facing tee.
- 6) Slide flat side of grab ring toward nut.
- 7) Push wide end of cone toward grab ring. Make sure narrow portion of cone has 1/4" to 1/2" of pipe exposed. If cone slides on with difficulty, apply a SMALL amount of DOW III Silicone Lubricant to the end of the pipe.
- 8) Slide nut and grab ring towards cone and hand tighten onto tee.
- 9) Turn nut by hand until tight. Additionally, tighten nut with wrench 1 to 1-1/2 complete turns. Be sure not to over tighten.
- 10) Install other nut in same manner as steps 4 through 9.
- 11) Leave the valve closed at this time.

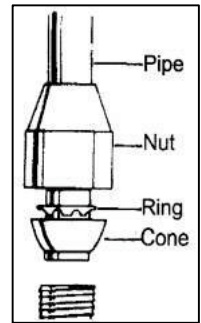

If Using C-Style Self-Piercing Saddle Valve (Optional – Not included with Aqua Magic Systems)



The C-Style Self-Piercing Saddle Valve is a great option for copper piping, but can also be used with hard steel, iron, brass, or CPVC piping. The simple mechanism fits 3/8” and 5/8” copper tubing. When the hand crank is turned, its ease-of-use technology pierces the cold feed water pipe. This opens the feed water line to its 1/4” compression nut connection. Self-Piercing mechanism is not intended for flex line tubing.

Installing on Soft Copper Pipe

- 1) Be sure the water supply is off.
- 2) Turn the valve handle counter clockwise until the lance (sharp point) does not protrude from the black gasket.
- 3) Position the valve around the cold water supply line (copper pipe) and insert the back plate. If the pipe is 3/8” in diameter, the small groove of the back plate must rest against the pipe. If the pipe is 5/8” in diameter, the large groove must be facing the pipe.
- 4) While holding the valve in place, tighten the screw.
- 5) To pierce the pipe, turn the valve handle clockwise.
- 6) When the valve handle becomes firmly seated, the pipe has been pierced and the valve is closed.
- 7) With the saddle valve still closed, turn on the sink faucet and water supply.
- 8) After allowing the water to flush away debris from the installation, turn off the faucet and check the valve for leaks. Leave the valve closed at this time.

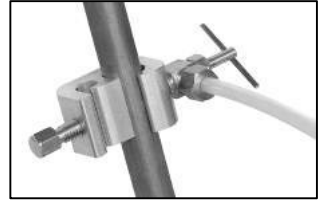

Installing on Hard Steel, Iron, Brass, or CPVC Pipe

- 1) Be sure the water supply is off.
- 2) Drill a 3/16” hole in the cold water supply line. A battery-powered drill should be used to avoid electric shock. Be extremely careful not to drill through the opposite wall of the pipe.
- 3) Turn the valve handle until the lance (sharp point) appears no more than 3/16” beyond the rubber gasket.
- 4) Place the lance over the hole so that it slides into the hole.
- 5) If the pipe is 3/8” in diameter, the small groove of the back plate must rest against the pipe. If the pipe is 5/8” in diameter, the large groove must be facing the pipe.
- 6) While holding the valve in place, tighten the brass screw.
- 7) Turn the valve handle clockwise until it is firmly seated and the valve is closed.
- 8) With the valve closed, turn on the sink faucet and water supply.
- 9) After allowing the water to flush away debris from the installation, turn off the faucet and check the valve for leaks. Leave the valve closed at this time.

If Using John Guest® Angle Stop Adapter Valve (Optional – Not included with Aqua Magic Systems)



The John Guest® Angle Stop Adapter Valve has been designed to easily tap into the cold water supply, right in between the cold water supply valve and the existing riser faucet line. Installation is fast and easy, without the need to pierce the feed line.

- 1) Be sure the water supply is off.
- 2) Disconnect the riser from the brass/chrome cold water supply valve.
- 3) Visually inspect the angle stop adapter valve to ensure that the sealing gasket is properly seated in the female threads.
- 4) Screw and securely tighten the angle stop adapter valve to the cold water supply valve.
- 5) Screw and securely tighten the riser to the angle stop adapter valve.
- 6) Leave the valve closed at this time.



Step 4: Install the Drain Saddle Clamp

Drain saddle clamps are used to direct the reject water of an RO system to drain. The provided drain saddle clamp is designed for a standard 1-1/2" OD drainpipe. Always inspect the condition of drainpipes before install and ensure they are not thin and frail. Drain saddle valve should not be installed near the garbage disposal; installation must be on the opposite pipe and above the cross bar pipe.

IMPORTANT: Drain saddle clamps are available with 1/4" and 3/8" tubing connections. Most air gap faucets require a 3/8" drain connection, while non-air gap faucet systems use a 1/4" drain connection. Identify your drain lines and confirm that your drain saddle clamp has the appropriate connection size.

IMPORTANT: For basement installations, drain saddle clamps may not be needed. Please see the **APPENDIX** at the end of this section for additional information.

CAUTION: Never install the drain saddle valve near the garbage disposal drainpipe. Backpressure caused by either unit may back water up into the system.



- 1) Place the small square black felt gasket, with a circle cut out of the middle, on the inside of the drain saddle. Peel off the sticky tape backing and adhere it to the inside of the drain saddle.
- 2) Position the drain saddle around the drain pipe at least 1-1/2" above the nut of the P-trap, to allow for the removal of the P-trap if necessary. Once in position, securely tighten the saddle clamp to the drainpipe.
- 3) Insert a 1/4" drill bit into the opening of the drain saddle and drill a hole in the drainpipe. Be extremely careful not to drill through the other side of the pipe.
- 4) Attach the black compression nut to the drain saddle, but do not tighten at this time.

Step 5: Install the Tank Shut-Off Valve

Locate the John Guest® tank shut-off valve included in the Parts Packet shipped with your system.

- 1) Wrap the male pipe threads (clockwise direction) on the top of the tank with Teflon tape.
- 2) Hand-tighten the tank shut-off valve to the top of the tank. Be sure it is tight, but do not over-tighten.
- 3) Turn the tank valve to the closed position for now.
- 4) For optimal flow, position the tank within 10 feet of the faucet.
- 5) Check the storage tank pre-charge pressure at the stem near the bottom of the tank. Tank pressure, when empty, should be 5 to 7 psi.

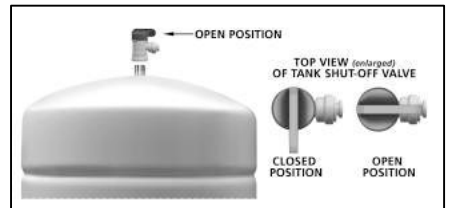

Step 6: Install the Filter Cartridges

While some models may have filter cartridges pre-installed, it's important to verify this in order to prevent permanent damage to RO membrane upon start-up.

- 1) Using the filter-housing wrench provided with the RO system, unscrew the filter housing sumps.
- 2) If not already installed, please remove the filter cartridges from their packaging, and insert the filter cartridges into their appropriate housing sump.
IMPORTANT: Your RO system may be suitable for a variety of filter cartridges. Always ensure that the appropriate filters are installed for proper pre-filtration.
- 3) Make sure that they slip down over the standpipe in the bottom of the filter housing sumps.
- 4) Verify that the o-ring is properly seated in the groove of the housing sump.
- 5) Turn the sumps, with the cartridges inside, back onto the appropriate cap – designated by the corresponding label. Firmly tighten, but do not over tighten.



Step 7: Mount RO System

The mounting bracket of the RO system, has pre-drilled slots for easy mounting. Depending on the location chosen, additional support may be needed to provide a firm and solid mounting of the system. To allow for future system maintenance, ensure there's at least 21" from the top of system to the floor.

IMPORTANT: For basement installations, please see the **APPENDIX** at the end of this section for additional information.

- 1) Using the bracket as a template, mark the mounting screw locations.
- 2) Drill 1/8" holes at each mark.
- 3) Install the screws and tighten them until the heads are about 1/8" from the wall
- 4) Hang the RO system on the mounting screws and hand-tighten up against the wall.
- 5) Keep the system in place while making the tubing connections.

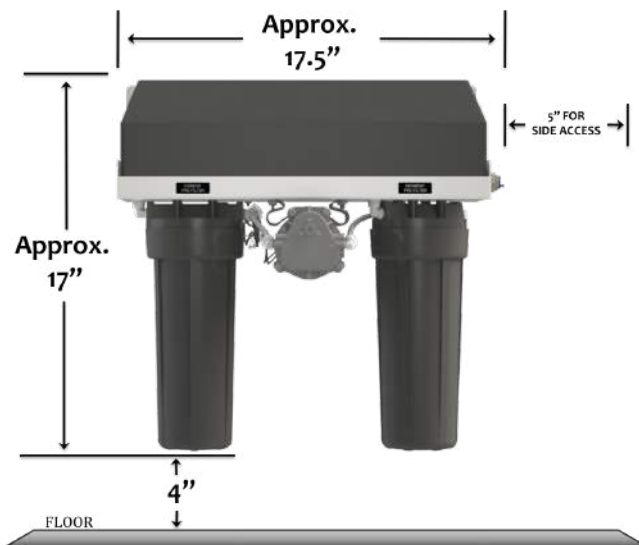

Step 8: Make Tubing Connections

This RO System makes the connection of your tubing lines very quick and easy! With side-port accessibility, color coded fitting plugs, and a color coded label, this step should be a breeze.

Please be sure to complete all prior steps before making tubing connections, and reference “Getting to Know Your System” and “Under-the-Counter Flow Diagram” in the earlier section to more easily identify the correct placement of tubing.

IMPORTANT: For basement installations, please see the **APPENDIX** at the end of this section for additional information.

When making tubing connections, follow these helpful tips:

- Attempt to keep tubing lines long enough to service the system later.
- Do not cut tubing at an angle. Cuts should be perfectly square.
- Insert tubing until it seats against stop inside of fitting. See “How to Make a Proper Quick Connect Tubing Connection” for more information.
- Only remove colored plugs from the fitting when you are ready to make the connection. Make one connection at a time, removing the colored plugs as you go.



Feed Water Connection (WHITE Plug)

- 1) Go back to the feed water valve you chose to install on the cold water supply line.
- 2) Using the coil of WHITE 1/4" tubing provided with the Parts Packet, connect one end into the feed water valve. Ensure connection is secure.
NOTE: If connection uses a compression nut, it's recommended to use a 1/4" tube insert. The insert is pushed into the end of the tubing, which supports it from collapsing.
- 3) Locate the **Feed Water Inlet** on your RO system. This should be identified with a 1/4" WHITE plug.
- 4) Remove the WHITE plug from the RO system, and connect the other end of the 1/4" WHITE tubing into the fitting. Ensure connection is secure.

NOTE: For basement installations, a longer length of feed water tubing may be needed.

Drain/Reject Water Connection (RED Plug)

In order for an RO system to function properly, there must be a certain amount of backpressure on the drain/reject line. Therefore, a drain line flow restrictor has already been installed for this purpose. It is located under the cover of the RO System and inserted at the end of the 1/4" RED tubing connection that comes out of the RO encapsulated membrane. Again, the manufacturer has already inserted this drain flow restrictor for you, but it's important to understand its purpose, and know its location.

The remaining drain/reject connection instructions will vary depending on whether you have an air gap faucet or a non-air gap faucet. Please only follow the steps that correspond to your type of faucet:

For a Standard Air Gap Faucet

- 1) At this point, one end of the provided 1/4" RED tubing should be connected to the **Drain/Reject Outlet** on your RO System, with the desired Drain Flow Restrictor installed.
- 2) Connect the other end of the 1/4" RED tubing to the 1/4" barb connector, found at the bottom of the air gap faucet. Ensure connection is secure.

- 3) Using the coil of 3/8" RED tubing provided with the Parts Packet, connect one end to the 3/8" barb connection, found at the bottom of the air gap faucet. Ensure connection is secure.
- 4) Locate the **Drain Saddle Clamp** (installed in a previous step) and unscrew the attached compression nut.
- 5) Slip the compression nut over the second end of the 3/8" RED tubing – making sure threads are facing the correct direction.
- 6) Find the 3/8" tube insert that was enclosed with the Parts Packet. Place this insert inside the second end of the 3/8" RED tubing.
- 7) Push the 3/8" RED tubing with insert into the **Drain Saddle Clamp**, and tighten with wrench until tight. Ensure connection is secure.

NOTE: When connecting the drain tubing, make a downward slope from the RO system to the drain saddle to allow for proper drainage. Avoid bending or kinking the drain tubing.

For a Standard Non-Air Gap Faucet

- 1) At this point, one end of the provided 1/4" RED tubing should be connected to the **Drain/Reject Outlet** on your RO System, with the desired Drain Flow Restrictor installed.
- 2) Locate the **Drain Saddle Clamp** (installed in a previous step) and unscrew the attached compression nut.
- 3) Slip the compression nut over the second end of the 1/4" RED tubing – making sure threads are facing the correct direction.
- 4) Find the 1/4" tube insert that was enclosed with the Parts Packet. Place this insert inside the second end of the 1/4" RED tubing.
- 5) Push the 1/4" RED tubing with insert into the **Drain Saddle Clamp**, and tighten with wrench until tight. Ensure connection is secure.

NOTE: When connecting the drain tubing, make a downward slope from the RO system to the drain to allow for proper drainage. Avoid bending or kinking the drain tubing.

Storage Tank Water Connection (YELLOW Plug)

- 1) Locate the **Storage Tank Outlet**, found on the side of the system. This should be identified with a YELLOW plug and will be the 3/8" bulkhead fitting directly below the **TANK** label.
 - a. Using the coil of 3/8" YELLOW tubing provided with the Parts Packet, remove the YELLOW plug and insert one end of the tubing into the fitting. Ensure connection is secure.
- 2) Locate the **Tank Shut-Off Valve** that you installed in an earlier step. Connect the other end of the 3/8" YELLOW tubing to this shut-off valve. Ensure the connection is secure.

Faucet Connection (BLUE Plug)

- 1) Locate the **Product Water Outlet**, found on the side of the system. This should be identified with a BLUE plug and will be the 3/8" bulkhead fitting directly below the **PRODUCT** label.
 - a. Using the coil of 3/8" BLUE tubing provided inside the Parts Packet, remove the BLUE plug from the RO system, and connect one end of the tubing into the fitting. Ensure connection is secure.
- 2) Locate the **Faucet Connector** that is attached to the previously installed faucet stem.
 - a. Connect the other end of 3/8" BLUE tubing to this fitting. Ensure connection is secure.

IMPORTANT: The product water of any RO system should not flow through copper pipe, as the purity of the water will leach copper into the water. This may cause an unpleasant taste in the water, and may also result in pinholes to form inside the pipe.

Step 9: Connect Booster Pump Transformer

Every Aqua Magic Low Pressure RO System includes the appropriately sized transformer for the booster pump. The Storage Tank Pressure Switch comes pre-connected to the system's booster pump. This leaves one unused female receptacle, found behind the RO system. Remove the transformer from its packaging, and connect the only unused receptacle to the transformer's receptacle.

CAUTIONS

1. The pump is equipped with either a fixed or adjustable bypass valve, which controls the maximum operating pressure. In addition, never subject the pump to pressures above 125 PSI (8.5 bars).
2. Never operate the pump in a harsh environment or hazardous atmosphere, since motor brush and switch may cause electrical arcing.
3. Pump-head materials are designed for use with water only. Do not use with petroleum products.
4. As long as there is feed water pressure, the pump will not stop forward flow of water even if the motor is turned off. Be sure the system has positive means of shutting off water supply.
5. Always consider electrical shock hazard when working with and handling electrical equipment. If uncertain, consult an Electrician. Electrical wiring should only be done by a qualified Electrician per Local and State Electrical Codes.

Step 10: Ice Maker Connection (Optional)

This RO system has been designed to easily connect to any standard refrigerator ice maker or ice maker/water dispenser. If you choose to connect your RO system to an ice maker, you will need additional hardware. It's recommended to use the following:

- ✓ LLDPE Tubing – 25' of 1/4"
- ✓ Reducing Tee – 3/8" (end) x 3/8" (end) x 1/4" (branch)
- ✓ Shutoff Valve 1/4" x 1/4"

TIP: If ice maker connection is being installed after the start-up of your RO system, any water in the system should be closed off. It's advised to close the feed water supply to your RO system, close the storage tank shut-off valve, open the dispenser faucet, and allow water to drain. A bucket should also be handy to catch any residual water when the product line is cut in the succeeding steps.

- 1) Locate the 3/8" BLUE tubing that runs from the **Faucet Outlet** to the dispenser faucet.
- 2) Using a tubing cutter, cut the tubing 5-10" past the point at which it comes out of your RO system. Allow any water that may be in the line to drain into bucket.
- 3) Using a reducing tee, 3/8" (end) x 3/8" (end) x 1/4" (branch), connect each end of the 3/8" BLUE tubing to the 3/8" connections on the reducing tee.
- 4) Connect one end of 25' of 1/4" tubing into the 1/4" branch of the reducing tee. Ensure all connections are secure.
- 5) 5-10" down the 25' tubing, cut it and connect an inline shutoff valve to each end.
IMPORTANT: This inline shutoff valve will allow you to shut off the water to your ice maker for future servicing and maintenance. Its installation is required.
- 6) Connect the remaining end of the 25' tubing to your ice maker.

NOTE: Shut-off valve to ice maker should always be closed during routine servicing, maintenance, and sanitization. Only open the shutoff valve when finished, and when RO system has been thoroughly flushed. This will prevent unwanted chemicals or particulates from entering the ice machine.

Step 11: Record Information in a System Maintenance & Repair Log

To ensure proper care and maintenance of your RO system, now is the time to begin a log, specifying the date of installation and the test results obtained at the original start-up. Additional data should be kept with dates and details of maintenance performed, along with test results at that time. Thorough records of any changes in system performance are important to have, should a problem ever arise.

APPENDIX: Basement Installations

Installing an RO system in the basement will result in some alternative installation instructions. This appendix is provided to complement the Installation Instructions in the previous section. Please read this appendix carefully, in addition to the installation instructions provided previously. The following are variations generally required for basement installations:

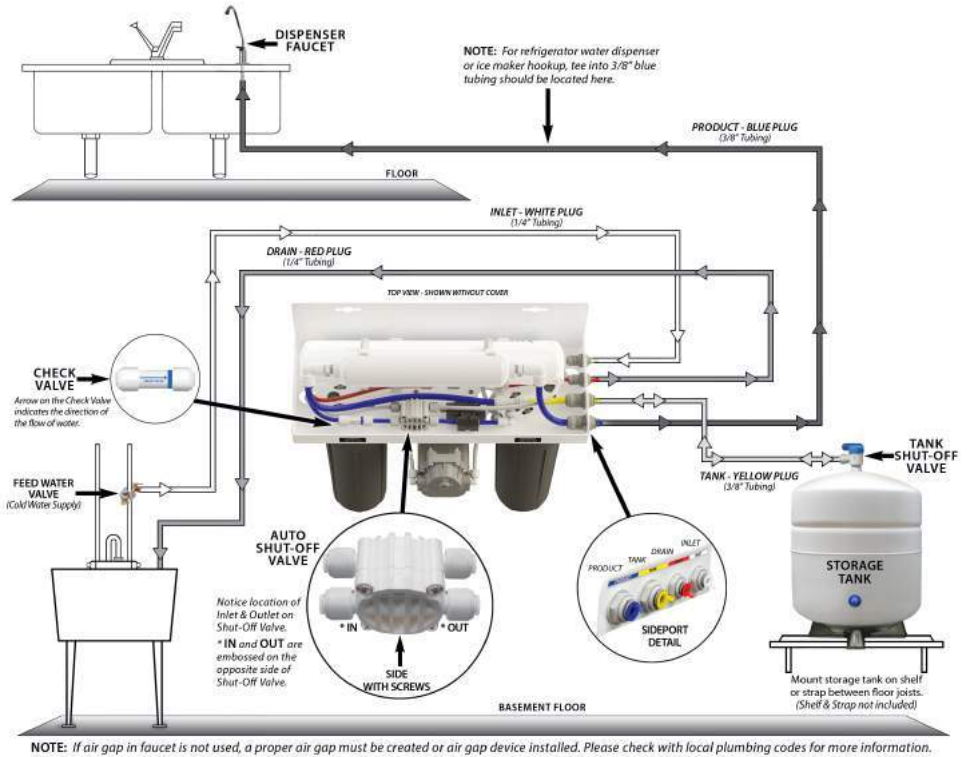

Faucet Installation

In basement installations, it's common to have your air gap located in the basement as well. Therefore, a specialized air gap dispenser faucet is generally not needed. A standard non-air gap faucet may be all you need, which requires a smaller (9/16") hole in the kitchen sink or countertop. An air gap faucet may still be used with basement installations, but it's recommended to not hook up any air gap tubing to the faucet since an alternative air gap will be used elsewhere in the drain line.

Install the Drain Saddle Clamp

For basement installations, the drain saddle is generally not used. Instead, the RO drain line is routed so that it drains into a laundry sink, floor drain, or standpipe through an approved air gap. An air gap of 1" is common in most cases, but a special air gap device may be used instead. Always check with local and state codes for applicable laws and regulations.

Mount RO System

The RO system is generally mounted to the basement wall (using wall anchors) or to wood ceiling supports. To mount the RO system, keep bracket level and mark the location of the mounting holes.

Install wall anchors and/or mounting screws as required. Leave screw heads protruding to allow the bracket's mounting holes to hook over them.

The storage tank may be oriented either vertically or horizontally and can be placed on a shelf, on the floor, or suspended from the ceiling supports using sturdy brackets. An effort should be made to minimize the distance between the tank and RO system to ensure proper flow to the faucet.

IMPORTANT: Always take caution and care when mounting equipment. Anticipate the weight of the system when full with water, and never install the RO system and its components in a way that creates a hazard. Special mounting brackets and hardware may be necessary for a secure and proper installation.

Make Tubing Connections

It's very common to require more tubing than was provided with your Parts Packet. However, an effort should be made to minimize the length of tubing as much as possible, while avoiding any loops, bends, and unnecessary lengths. Long connections will inhibit the performance of your RO system, and may affect its overall performance. A deliver pump may be needed to assist output to dispenser systems.

Product Water Connection (BLUE Collet/Plug): In connecting the 3/8" BLUE tubing from the **Faucet Outlet** of your RO system to an upstairs dispenser faucet, tubing must be routed through the floor to the vicinity of the RO system.

Drain/Reject Water Connection (RED Plug): Connect 1/4" RED tubing to the **Drain Outlet** of your RO system and then route the opposite end to an appropriate drain connection (e.g. laundry sink, floor drain, stand pipe, etc.). Most local and state codes require an air gap between the outlet and the drain connection. A specialized air gap device may also be used.

Section 7: Start-Up Procedure

With the sediment/carbon pre-filter cartridges installed, and all tubing and tank connections in place, your RO system is ready for start-up! During start-up, it's crucial to thoroughly flush the system before the water is ready for consumption. Please follow these steps closely to ensure a proper start-up:

- 1) Slowly open the feed water shut-off valve that you installed on the cold water supply line.
- 2) Check the system carefully for any initial leaks.
- 3) Open the water storage tank shut-off valve.
- 4) Open the dispenser faucet. The RO system should now begin making water.
- 5) Close the dispenser faucet as soon as water begins to flow and do not open again until the storage tank is full. Check the system for leaks once again.
- 6) After the tank is full (you will hear the water stop), open the dispenser faucet and completely drain the tank and RO system.
- 7) When the faucet is first opened, expect air and carbon fines (very fine black powder) from the carbon filters to be rinsed out. This is completely normal for the first tank of water or after carbon filters are changed.
- 8) After the system has been drained, close the faucet and repeat this flush cycle two more times. **DO NOT DRINK THE WATER UNTIL THE TANK AND SYSTEM HAVE BEEN FLUSHED AT LEAST THREE TIMES.**
- 9) Test the product water at this time to ensure that the system is operating properly.
- 10) The RO system is now ready for use!

You may notice that the water is milky colored during the first week. It is due to the air bubbles in the water. It is normal and safe to drink.

IMPORTANT: This RO system contains replaceable treatment components critical for effective performance. Replacement of the system components should be done with one of identical specifications, in order to attain the same efficiency and contaminant reduction as originally designed. It is the user's responsibility to periodically test the product water to verify the system is performing satisfactorily.

We recommend opening the dispenser faucet for at least 10 seconds prior to using the water. This is especially important if the RO water is not used daily. After periods of non-use, such as a week of vacation, it is better to empty the storage tank and allow the system to produce fresh water for use. If the RO system is not used for 3 to 4 weeks, we recommend you sanitize the system and change the filter cartridges. Longer periods of non-use may require additional service from a water treatment professional in your area.

Check for leaks daily for the first week, and periodically thereafter.

Section 8: Maintenance Procedures

Filter Cartridge and RO Membrane Replacement

This RO system contains filter cartridges that must be replaced regularly to maintain proper performance. The recommended schedule for changing the filter cartridges (not the RO membrane) is every 3 to 6 months, depending on the quantity of water used and the feed water conditions.

The typical RO membrane life expectancy (assuming adequate filter changes are done) is two to four years. The life of the RO membrane also depends greatly on the incoming water conditions and the amount of water used. Normally, replacement of the RO membrane is necessary whenever the product water begins to take on a different and objectionable taste, if there is a noticeable reduction in the amount of product water (after replacing the filter cartridges), or a change in the TDS level of the product water.

Replacing Filter Cartridges

- 1) Use a drip pan or bucket to catch any water that may spill when the filter housing sumps are removed.
- 2) Close the shut-off valve installed on the cold water supply of feed line.
- 3) Close the shut-off valve installed on the storage tank.
- 4) Close any additional dispensing lines, such as an ice-maker (also turn off the ice maker).
- 5) Open the dispenser faucet to allow residual water in the system and its lines to empty. Leave the faucet open.
- 6) Using the spanner wrench supplied with your system, remove the filter housing sumps (Fig 8-1). Use one hand to hold the system and the other hand to turn the wrench clockwise to open. Any residual water inside sumps can be poured out.
- 7) Remove the used cartridges and discard.



Fig 8-1

IMPORTANT: Take careful note of which filter cartridges you removed from each sump. It's important for the filter cartridges to be replaced correctly. Please reference the "Getting to Know Your System" section for more information.

- 8) Wash the inside of the sumps using a mild detergent and soft cloth. Do not use abrasive cleaners or pads. Thoroughly rinse all the soap from the sumps.
- 9) Remove the o-ring from each sump and wipe the groove and o-ring clean. Lubricate the o-ring with a clean coating of food grade silicone, or water-soluble lubricant, such as glycerin, canola oil, or vegetable oil. **DO NOT** use petroleum-based lubricants, such as Vaseline.
- 10) Place the o-ring back in the groove and press it in with two fingers (Fig 8-2). It's important to make sure that the o-ring is seated properly. If the o-ring appears damaged or crimped, it should be replaced.
- 11) Remove the new filter cartridges from their wrapper.
- 12) Insert each filter into the corresponding housing sump, paying careful attention to the system labels. Labels will indicate the proper replacement of filters. Please reference the "Getting to Know Your System" diagram at the beginning of this manual for more information.
- 13) Make sure that the filters slip down over the standpipe in the bottom of the filter housing sump.



Fig 8-2

- 14) Turn the sumps, with the cartridges inside, back onto the housing cap. Firmly tighten, but do not over tighten.
- 15) Flush the system as follows:
 - a. Be sure the storage tank valve is still closed.
 - b. Slowly open the feed water saddle valve on the inlet water line. Check the system carefully for any leaks.
 - c. Water should begin flowing through the already open dispenser faucet. Allow water to flush until clear. This may take 5-10 minutes.

NOTE: When the faucet is first opened, expect air and carbon fines (very fine black powder) from the carbon filters to be rinsed out. This is normal after carbon filter changes.

IMPORTANT: Do not drink the water until the system and new filters have been thoroughly flushed.
- 16) Test the product water at this time to ensure that the system is operating properly.
- 17) Storage tank valve can now be opened at this time, along with any other dispensing lines.
- 18) The RO system is now ready for use.

IMPORTANT: To prevent costly repairs or possible water damage, housing sumps should be replaced every 5 to 8 years. Be sure to date any new or replacement sump for future reference and indicate the next recommended replacement date.

Changing the RO Membrane

Although changing the RO membrane is optional when replacing filter cartridges, it is important to replace filter cartridges whenever replacing the membrane.

- 1) Carefully disconnect the tubing connections and remove the encapsulated membrane from the plastic clips mounting it to the metal bracket.

IMPORTANT: Take special note of the connections to the encapsulated membrane to ensure they are properly replaced.
- 2) Remove packaging from a new encapsulated membrane, and verify that it matches the specifications of the previous encapsulated membrane.
- 3) Snap encapsulated membrane back into the plastic clips.
- 4) Reconnect the three tubing lines to the quick-connect fittings – referencing the “Flow Diagram” and “Getting to Know Your System” sections if needed.

Sanitizing the RO System and Storage Tank

Sanitizing the RO system is optional with filter cartridge replacement, but required annually. This procedure is not intended to be effective in sanitizing highly contaminated systems which have been exposed to an excessive amount of bacteria, or systems which have developed foul smelling RO membranes or filters. Such systems require extensive cleaning and sanitizing. Consult your dealer for further information.

- 1) Close the shut-off valve installed on the cold water supply of the feed line.
- 2) Close any additional dispensing lines, such as an ice-maker (also turn off the ice maker).
- 3) Ensure the shut-off valve installed on the storage tank is open.
- 4) Open the dispenser faucet to allow water in the system and tank to empty.
- 5) Close the dispenser faucet when water stops flowing.
- 6) Using the spanner wrench supplied with your system, remove the filter housing sumps. Use one hand to hold the system and the other hand to turn the wrench clockwise to open. Any residual water inside sumps can be poured out.
- 7) Temporarily remove all filter cartridges from the RO system at this time. Leaving them in during the sanitizing process may cause permanent damage and prevent proper sanitization.
- 8) Using a good quality unscented liquid chlorine household bleach. Pour approximately one teaspoon into each filter housing sump of your RO system.

IMPORTANT: Do not use more than the recommended amount of liquid chlorine household bleach. Doing so may cause permanent damage to the encapsulated membrane.

- 9) Temporarily replace the housing sumps onto the filter housing caps, without any filter cartridges inside. Firmly tighten.
- 10) Slowly open the feed water valve and allow water to enter the system.
- 11) Open the dispenser faucet.
- 12) As soon as the sanitizing solution can be detected (by smell) from the dispenser faucet, turn the dispenser faucet closed.
- 13) Wait for the storage tank to fill with water (you will hear the water stop when full), and then close the feed water valve. Check the system for any leaks.
- 14) Do not open the dispensing faucet or feed water valve again for at least 6 hours.
- 15) After 6 hours, open the dispenser faucet and drain the system.
- 16) Once completely drained, filter cartridges can be returned to their appropriate filter housing sumps. Please reference the “Replacing Filter Cartridges” Section for additional information.
- 19) Flush the system as follows:
 - a. Be sure the storage tank valve is open.
 - b. Slowly open the feed water valve on the inlet water line. Check the system carefully for any leaks.
 - c. Close the dispenser faucet as soon as water begins to flow and do not open it again until the storage tank is full. Check the system again for any new leaks.
 - d. After the tank is full (you will hear the water stop), open the dispenser faucet and completely drain the tank and RO system.
 - e. When the faucet is first opened, expect air to be flushed out. If filter cartridges were also replaced, there may be carbon fines (very fine black powder) being rinsed out too. This is normal after carbon filter changes.
 - f. After the system has been completely drained, close the faucet and repeat this flush cycle two more times.
- 20) Test the product water at this time to ensure that the system is operating properly.
- 21) The RO system is now ready for use, and any other dispensing lines (e.g. ice-makers) can now be opened at this time.

IMPORTANT: DO NOT DRINK THE WATER UNTIL THE TANK AND SYSTEM HAVE BEEN FLUSHED AT LEAST THREE TIMES.

IMPORTANT: Periodically check all tubing lines for wear, discoloration, kinks, or cracks. Replace whenever in doubt to avoid leaks. This may also be a good time to consider replacing the drain line flow restrictor.

Section 10: System Troubleshooting

PROBLEM	POSSIBLE CAUSE	SOLUTION
Low Quantity of Product Water from Storage Tank	Feed water saddle valve is plugged or clogged.	Open valve or unclog.
	Clogged sediment/carbon pre-filter.	Replace filters.
	Low water pressure.	Feed Water pressure must be above 40 psi.
	RO membrane is fouled.	See Feed Water operating limits. Correct cause of fouling, replace Membrane
	Plugged inline activated Carbon Post-Filter.	Replace Post-Filter.
	Air pre-charge pressure in storage tank is too high.	Empty water from storage tank, and with the faucet open, adjust air pressure to 5–7 psi (35–48 kPa) range.
	Air pre-charge pressure in storage tank is too low.	
	Air bladder in storage tank is ruptured.	Replace storage tank.
	Storage tank valve is closed	Open valve.
	No drain flow; the drain flow restrictor is clogged.	Clear or replace
	The check valve in encapsulated membrane is stuck.	Free check-valve or replace with new encapsulated membrane.
	The automatic shut-off valve is malfunctioning.	Replace automatic shut-off valve.
Low Pressure at the Dispensing Faucet	Carbon post-filter is plugged.	Replace post-filter.
	Air pre-charge in the storage tank is too low.	Empty water from storage tank and with the faucet open, adjust the air pressure to the 5-7 psi (35-48 kPa) range.
		Check for leakage at the air valve stem.
	Storage tank shut-off valve is partially closed.	Open valve.
	The dispensing faucet is out of adjustment or faulty.	Repair or replace dispensing faucet.
	Heavy water use, storage tank is depleted.	Allow storage tank to refill (adding a second storage tank will increase the storage capacity).
Low water production.	See “Low Quantity of Product Water from Storage Tank” above.	
High Total Dissolved Solids (TDS) in the Product Water	Clogged sediment/carbon pre-filter.	Replace filters.
	Low Water Pressure.	Feed water pressure must be above 40 psi.
		Check feed water valve.
	RO membrane is faulty.	Replace membrane.
RO membrane is expended.	If membrane life is unusually short, inspect further and replace membrane.	

<i>(continued)</i> High Total Dissolved Solids (TDS) in the Product Water	The product water and drain water lines are reversed.	See flow diagram and correct plumbing.
	No drain flow, the drain orifice in the dispensing faucet is plugged.	Clear or replace dispensing faucet.
	No drain flow, drain flow restrictor is clogged.	Clear or replace drain flow restrictor.
	The automatic shut-off valve is not closing.	Repair or replace the automatic shut-off valve.
	New inline or activated carbon pre-filter not rinsed completely.	Flush with several full tanks of product water.
	The feed water TDS has increased.	An increase in feed water TDS will give corresponding increase in product water TDS.
Tastes and Odors in the Product Water	The inline or activated carbon pre-filter is exhausted.	Replace filters.
	There is foreign matter in the storage tank.	Clean, flush and sanitize the system. Replace the filters.
	The product water and drain water lines are reversed.	See flow diagram and correct plumbing.
	Dissolved gasses in the feed water.	Pre-treat feed water to remove dissolved gasses.
	Increase in product water TDS.	See high “High TDS in the Product Water” section above.
Water Continues to Flow Down Drain	RO System is correctly running.	While the RO System is running and making your water great, it is perfectly normal to hear water flowing to drain. This process will continue until your pressurized storage tank is full. If flow to drain continues after tank is full, then inspect Drain Flow Restrictor.
	Drain Flow Restrictor is not Installed.	Drain Flow Restriction is included with RO System. Some models have the Flow Restrictor installed for you, other models with have it taped and identified to the RO membrane packaging. Inspect Drain line and ensure it is properly installed. This is typically located where the 1/4” tubing connects with the Drain line connection of the membrane.
Drain Water Overflows Beneath the Dispensing Faucet	Air gap is blocked.	Clear Air Gap. Rinse with vinegar for removal of calcium buildup.
	Drain tubing is clogged.	Clear tubing.
	Drain clamp hole is misaligned.	Align the hole in the drainpipe.
	Excessive drain flow rate.	Replace drain flow restrictor.
Faucet Leaks or Drips	Leaks from base of the delivery tube.	O-ring is bad. replace o-ring.
Fitting Leaks, in General.	Close the Feed Water Saddle Valve and relieve pressure before disconnecting any tubing or replacing any fitting. Before replacing a fitting, re-cut the tubing and re-insert into the fitting to see if that solves the leak. If pipe threads are leaking, remove and re-tape with Teflon tape.	

Booster Pump Troubleshooting

- ❖ The pump will not run:
 - Start at the source to determine if and where the electrical current flow has been interrupted. Use a multi-meter to check the line voltage, and the transformer output. If the transformer is not functioning properly, its current capacity may have been exceeded.
 - If the transformer is properly sized, and is delivering the correct voltage to the system, remove the storage tank pressure switch from the system by disengaging both connectors/receptacles, and connecting the pump directly to the transformer.
 - If the pump now runs, the pressure switch is faulty, and needs adjusting or replacement.
 - If the pump still fails to run, the electrical path has been interrupted within the motor, and will need to be replaced.
- ❖ The flow and/or pressure is too low:

Most booster pumps are designed to limit the maximum output pressure to 110 psi, to protect the membrane and other components from damage. The normal operating pressure as measured after the pump, and before the membrane, will be approximately 80 psi. Please verify the booster pump's certified flowrate. If these parameters are not being met, please check the following:

 - Is the pump properly sized to handle the production rate of the membrane, plus the brine flow allowed by the restrictor (usually 4 or 5 times the permeate production)?
 - Is the system receiving adequate feed water? The pump's inlet chamber must be flooded to prevent performance robbing air ingestion into the compression chambers.
 - Debris entering the pump, such as residue from an activated carbon filter improperly located on the inlet side of the pump, may restrict the pumping operation. Consult the factory for valve cleaning instructions.
- ❖ The pump will not shut off:

This is usually caused by a pressure switch that is one of the following:

 - Not mounted to properly sense the pressure in the storage tank.
 - Will not open at a pressure less than the minimum allowed by an automatic shut off valve. Check with the supplier of the RO system. If the shut off valve stops the flow of feed water before the storage tank reaches the shut off pressure setting of the switch, the switch will remain closed, and the pump will run continuously. Using a pressure switch with a lower psi shut-off point can fix this problem.
 - Check pre-filter(s). Replace if necessary. A partially or fully clogged pre-filter may cause the pump to run continuously.
- ❖ The pump operation is too noisy:

Booster pumps operate at relatively slow speeds, accounting for their quiet operation. Pumps that exceed expected noise levels usually have one of the following problems:

 - Entrapped air (which will eventually dissipate). Make sure air is not being drawn into the pump.
 - Water may have damaged the bearings, or other motor components. Check for internal leaks, as well as water entering the motor from an external source.
 - Squeaking may be associated with the by-pass mechanism; brush contact with the commutator surface; or inadequate lubrication in the rear bearing. Consult the factory.
- ❖ The pump is causing electrical noise interference:
 - Try locating the pump on a dedicated electrical circuit, separate from the device that is being interfered with.
 - Consult factory for pumps available with electronic noise suppression.
- ❖ Can a Permeate Pump and a Booster Pump be used together in an R.O. system?
 - Yes. The Booster Pump increases the feed water pressure to the membrane, while the Permeate Pump is located after the membrane and eliminates the performance robbing backpressure created by a full, or filling, air charged storage tank.

Section 11: Product Warranty

REVERSE OSMOSIS SYSTEM LIMITED WARRANTY

The manufacturer warrants that each RO system is free of defects in material and workmanship and has been factory tested to perform in accordance with published specifications at the time of shipment. The manufacturer further warrants that the RO system will continue to operate for a period of one (1) year from start-up, or 15 months from purchase, whichever is shorter, provided that the user supplies feed water meeting minimum standards stated in the Owner's Manual and adopts and implements the maintenance program recommended in the Owner's Manual.

Parts and components, which are sold in tandem with the RO system, are subject to the warranty of their original manufacturer. Expendable or consumable products, filter cartridges, chemicals, etc., which by nature have a shorter life expectancy than twelve months, are not covered under this warranty.

The manufacturer's liability under this warranty is limited to the repair or replacement at the manufacturer's discretion of systems or components, F.O.B. the manufacturer's factory, found defective solely as to materials or workmanship during the warranty term. The manufacturer will not be liable for any cost for removal, installation, transportation, or any other charges that may arise in connection with a warranty claim. This warranty does not extend to any system or components which failed due to; 1) Damage from mishandling, misuse, abuse, abnormal operating conditions, improper maintenance procedures, accident, unauthorized modification, or neglect, 2) Improper installation or, 3) Incorrect electrical supply. This warranty is void if serial numbers are mutilated or missing.

The membrane elements are guaranteed to operate within specifications when used for general water treatment for a period of 12 months from date of purchase providing that the membrane element has not been misapplied or used with feed water that does not meet the minimum standards stated in the Owner's Manual.

A membrane element, which fails to perform satisfactorily within the first 30 days after receipt, has not been mishandled or misapplied, and is returned prepaid to the manufacturer's factory, will be replaced free of charge except for freight and local labor. If a membrane element fails to perform satisfactorily during the balance of the warranty period, and is returned prepaid, the manufacturer will replace the membrane element with a new membrane element and will charge the returner for the portion of the 12 months that the membrane element was used plus the return freight. The pro rata charges will be based on the price prevailing at the time of warranty consideration. Membrane elements must be kept damp at all times and must be clean and bagged in a watertight bag before returning.

To obtain warranty consideration, the defective product must be returned to the manufacturer prepaid together with proof of purchase, installation date, failure date and supporting technical data. All documentation supporting the warranty claim and a Returned Goods Authorization (RGA) number must be included.

























THE MANUFACTURER'S OBLIGATION UNDER THIS WARRANTY IS LIMITED TO REPAIR OR REPLACEMENT OF THE DEFECTIVE PART. THE MANUFACTURER ASSUMES NO LIABILITY WHATSOEVER FOR INCIDENTAL OR CONSEQUENTIAL DAMAGES, LOSSES OR EXPENSES ARISING FROM INSTALLATION, USE OR ANY OTHER CAUSES. THERE ARE NO EXPRESSED OR IMPLIED WARRANTIES BEYOND THOSE WARRANTIES DESCRIBED OR REFERRED TO ABOVE.



FRAKCO

Replacement Parts List

*Aqua Magic Warden Pro LP
with 50 GPD Membrane*

MEMBRANE ELEMENTS		FLOW RESTRICTOR	
	#GRO50EN Encapsulated Membrane, GRO, with In-Line Check Valve – 50 GPD		#49200260 Black, Capillary – 50 GPD
FILTER CARTRIDGES		FAUCET	
	#PF32510 Sediment/Carbon Filter, 5 Micron		#LRAG14C Faucet, Air Gap, Long Reach, Chrome
	#MB0509880006 Sediment Filter, 5 Micron		#LRIC Faucet, No Air Gap, Long Reach, Chrome
	#GA-K2540BB Carbon In-Line Filter, 1/4" NPT x 1/4" NPT		#PP3212UFW Faucet Connector 3/8"
FILTER HOUSINGS		MISCELLANEOUS	
	#PF158120 Filter Housing, 10" Slim Line, 1/4" NPT		#GL3170903 Auto Shut-Off Valve, JG Quick Connect
	#PF150539 Filter Housing Wrench		#IF027 Drain Saddle Clamp
	#PF151121 Filter Housing O-Ring		#IF030 Mur-lok® RO-Pal, 5/8" OD x 1/4" FPT Ball Valve End
BOOSTER PUMP			#PP10822W Male Connector, 1/4" FPT x 1/4" QC <i>For use with Mur-lok® RO-Pal</i>
	#GL30568000 Booster Pump, 1/4" JG, 24VAC,	TANK	
	#GL30590012 Booster Pump Transformer, 115VAC/60HZ		#C-1999F Storage Tank, White, 4.4 Gal
	#GL30590005 Storage Tank Pressure Switch, 20/40 On/Off		#PPSV501222W Tank Shut-Off Valve, 1/4" NPT X 3/8" Tube
OPTIONS & ACCESSORIES			
	Luxury Euro Style Faucet, No Air Gap #030218 Chrome #030228 Brushed Nickel #03053 Oil Rubbed Bronze #03051 Black #03050 White #03043 Polished Brass		#075019 Inline TDS Monitor, QC-1
	Luxury Euro Style Faucet, Air Gap #030219 Chrome #030229 Brushed Nickel #030539 Oil Rubbed Bronze		#44001 Collet Release Tool <i>For 1/4" & 3/8"</i>
			#075046 Pocket TDS Tester
			#44002 Tube Cutter

MANUFACTURED BY: FRAKCO, INC.
500 N BLUE MOUND AVE
LIVERNE, MINNESOTA 56156
WWW.FRAKCO.COM

6/20/2024