

DROP

The Smart Water System



Installation Manual

Reverse Osmosis System

Available on the
 App Store

ANDROID APP ON
 Google play

 amazon alexa

 Home Assistant

 CHANDLER SYSTEMS

INTRODUCTION

Thank You for Purchasing a DROP Reverse Osmosis System!

This simple system fits right under your sink and gives you crystal clear, great tasting water. The DROP RO System does this by reducing contaminants including chlorine, lead, pesticides, fluoride, pharmaceuticals, arsenic and bacteria. Additionally, the RO eliminates sediment in your water. The DROP RO System will give you water with improved taste, odor and appearance.

Be sure to check out the dropconnect.com website periodically for more information about additional DROP products as they are released.



833.BUY.DROP
(833.289.3767)



dropconnect.com

To further help you operate your new DROP system, we have provided you with many other resources for you to learn more. Feel free to call Chandler Systems when you need additional help. We also have many resources located on our website including instructional videos, and images.

DROP Connect is also active on various social media pages! Feel free to follow us for the most up to date information and news!



@dropconnect

Privacy Statement

For more information about privacy, visit our [privacy policy](https://dropconnect.com/sites/default/files/DROP-Privacy-Statement.pdf) (<https://dropconnect.com/sites/default/files/DROP-Privacy-Statement.pdf>) online.

DROP Patents

For the most up-to-date list of patents, visit our patents on our website: <https://dropconnect.com/patents>.

FCC Compliance Statement:

https://dropconnect.com/sites/default/files/FCC_Compliance_Statement.pdf

Industry Canada Compliance Statement:

https://dropconnect.com/sites/default/files/Industry_Canada_Compliance_Statement.pdf



TABLE OF CONTENTS

Introduction.....	2
Table of Contents.....	3
About Your System.....	4
Contents of Carton.....	5
Warnings.....	6
CartridgeFunction.....	7
Installation Instructions.....	8
Install App.....	14
Stand Alone Mode.(For use with out the DROP Hub).....	16
Warranty.....	1



ABOUT YOUR SYSTEM

- **Pure and Simple:** DROP has elevated your standard RO to a whole new level. The DROP RO System offers WiFi connectivity through the DROP Hub. Additionally, it offers quick change for the filters and the RO Membrane. Text, email or push notifications notify when it's time to change your filter.

Additional Features You'll Find on Your DROP Reverse Osmosis System



- Quick Change Filters and RO Membrane
- Built-in Leak Protection
- TDS Monitoring of Feed & Product Water
- Text, Email & Push Notifications for Filter change outs when used with a DROP Hub
- Atmospheric Storage - No Backpressure on Membrane for faster RO water production
- Built in Feed & Delivery Pumps for Optimal Pressure
- WiFi Connectivity Through DROP Hub

Model	D-RO
Dispenser Pump Flow Rate	0.6 gpm
Production Rate	6 gallons per hour
Efficiency Rating	1:1 (most RO filters are 4:1)
Maximum TDS	1000 ppm
Drain (reject water) Flow	0.1 GPM (only while filtering)
Storage Tank Capacity	2.1 gallons

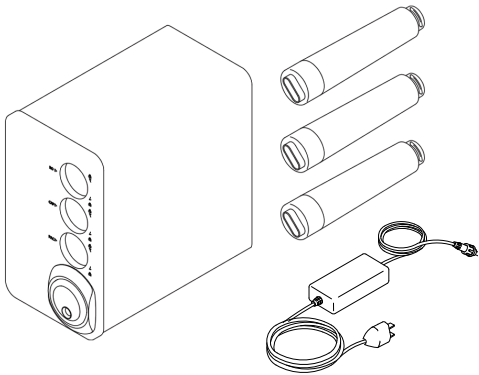
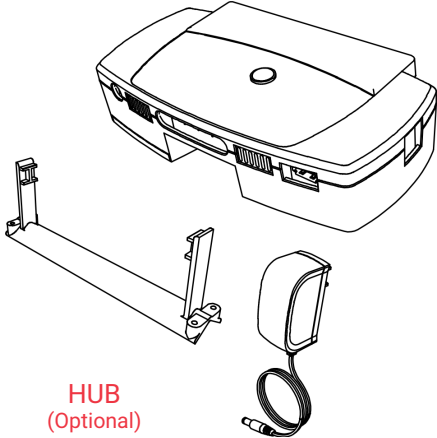
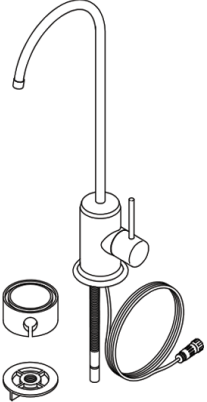
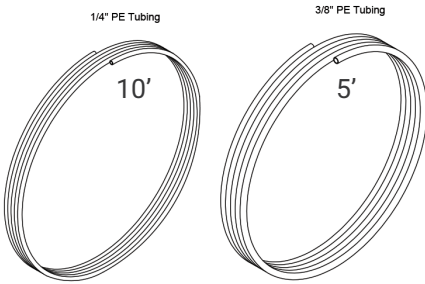
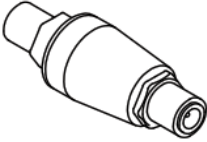
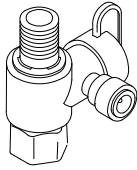

CONTENTS OF CARTON

Contents of Carton

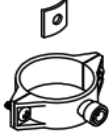
 <p>REVERSE OSMOSIS SYSTEM w/ CARTRIDGES</p>	 <p>HUB (Optional)</p>
<p>RO FAUCET</p> 	<p>1/4" PE Tubing 10'</p> <p>3/8" PE Tubing 5'</p>  <p>RO TUBING</p>
<p>PRESSURE REGULATOR</p> 	<p>ANGLE STOP VALVE ADAPTER</p> 
<p>FAUCET ADAPTER</p> 	<p>DRAIN SADDLE CLAMP & GASKET</p> 

WARNINGS

Precautions

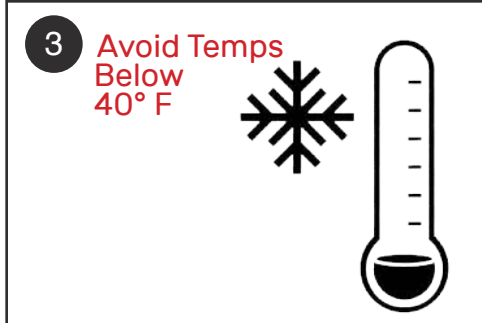
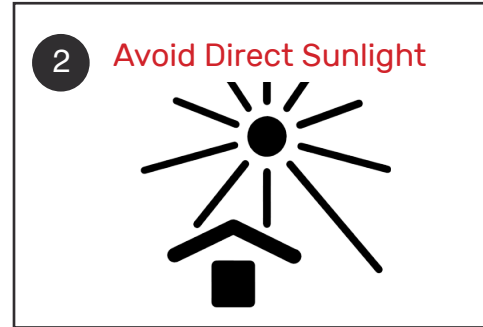
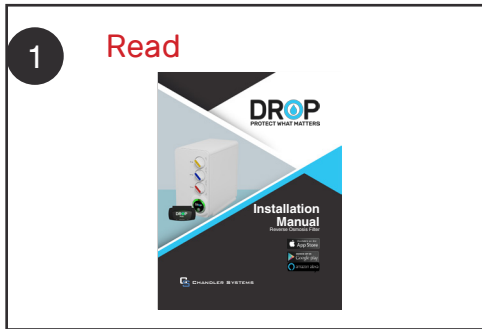

WARNING: Read carefully the product installation & operation instructions. Failure to follow the instructions and warnings in the manual could void the product warranty.

WARNING: When errors occur, immediately shut off power and water supply.

CAUTION: Do not disassemble the machine without the guidance of professional personnel to avoid leakage or damage. Only professional personnel can repair and maintain this system. Attempts to repair a DROP RO System in the field will void the warranty. Please contact the factory if you believe repairs are needed.

CAUTION: The DROP RO System should be used in 40° F - 100° F temperatures.

CAUTION: Only use the accessories and cartridges from DROP by Chandler Systems.



CARTRIDGE FUNCTION

Cartridge	Treatment	Filtration	Water	pH Level
RO-PAC	Removes dirt corrosion, sand and other suspended solids	5 microns	41 ° - 95 ° F	NA
RO-CAP	Removes odor to improve the taste of drinking water	1 micron	41 ° - 95 ° F	NA
RO-RO	Removes small molecular organic matter, colloids, microorganisms	0.0001 micron	41 ° - 95 ° F	NA
RO-MPC (optional)	Cartridge boosts the pH and adds beneficial minerals magnesium and calcium to the drinking water	NA	41 ° - 95 ° F	7.5-8

INSTALLATION INSTRUCTIONS

Installation of Angle Stop Valve Adapter

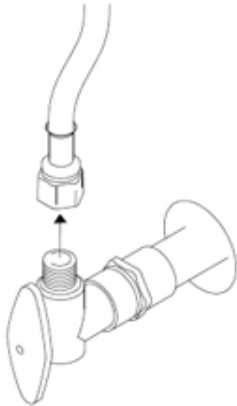

Turn off the cold water shut off valve and disconnect the supply line from the shut off valve.



Connect the supplied angle stop adapter valve to the shut off valve and connect the supply line to the top of the angle stop adapter valve.

Connection of Ports

NOTE: The supplied 1/4" tubing is used for both the feed water supply and the drain water port. Please plan accordingly and carefully cut appropriate lengths for each from the supplied tubing, making a clean square cut.

*

Inlet Feed Water Port - Connect one side of the 1/4" tubing to the inlet water valve and the other end into the inlet water port on the RO System.

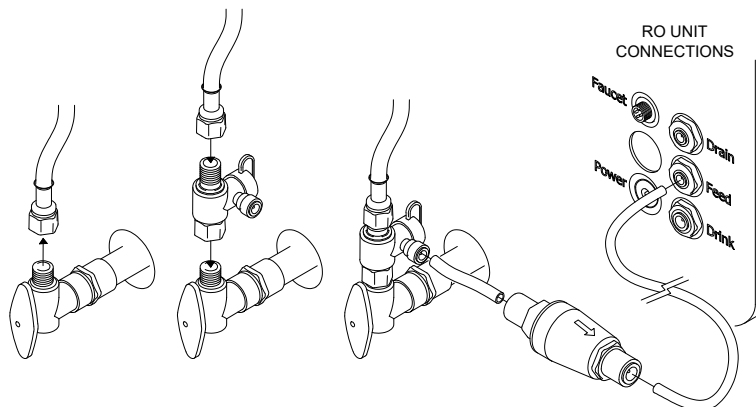

Inlet Water Port - Cut a short segment from the supplied 1/4" tubing (~12") to install between the shutoff valve and the pressure reducer. The remaining tubing is installed between the pressure reducer and the RO System's 'FEED' port. Also, the pressure reducer needs to be installed with the arrow on the reducer pointing in the direction of flow from the water supply to the RO unit.



INSTALLATION INSTRUCTIONS



Drain Water Port

NOTE: The supplied 1/4" tubing is used for both the feed water supply and the drain water port. Please plan accordingly and carefully cut appropriate lengths for each from the supplied tubing, making a clean square cut.

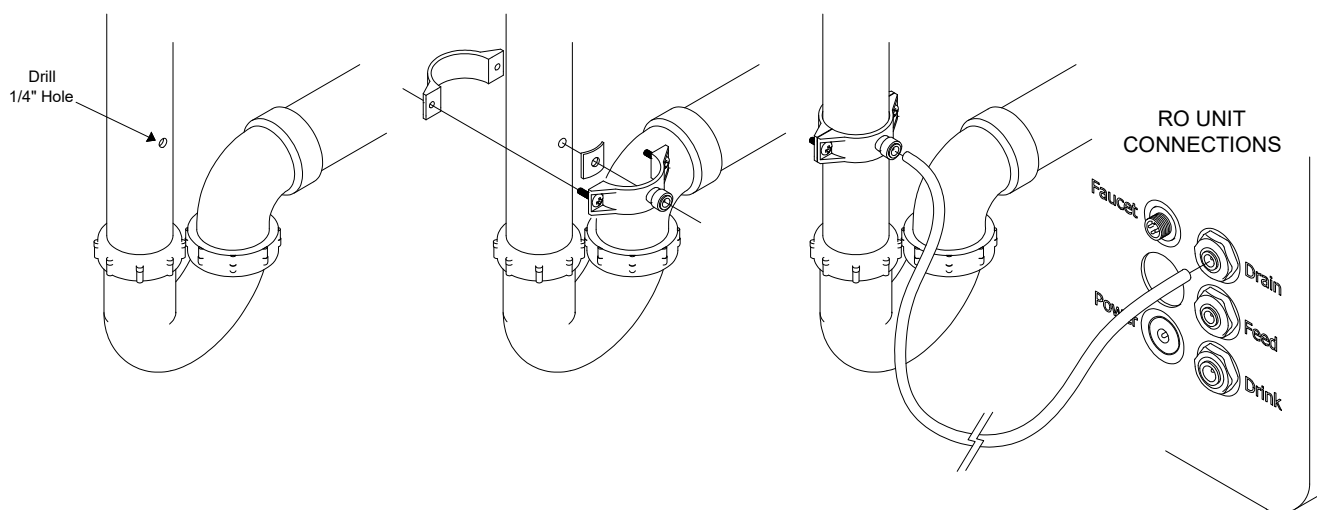

Drain Water Port - Drill a 1/4" hole in the existing drain well above the trap. Remove the center punch-out from the included saddle clamp gasket and adhere the gasket over the 1/4" hole in the drain pipe. Install the drain saddle clamp with the port centered over the hole in the drain pipe.

Use a sharp knife to cut a length of the supplied 1/4" tubing that will reach from the port in the drain pipe to the port on the RO system marked 'DRAIN'. Connect one end to the 'DRAIN' port on the RO system, and the other end to the port in the saddle clamp.

- For replacements filters visit www.dropconnect.com/accessories/ or call **1-888-BUY-DROP**.
- Only replace with genuine DROP by Chandler Systems filters.
- The app will alert you when there is 15% filter life remaining and when it is time to change your filter.

NOTE: Follow local plumbing codes - use of an air gap may be necessary when connecting directly to the drain.

INSTALLATION INSTRUCTIONS

*

Installation of Faucet and Drinking Water Port

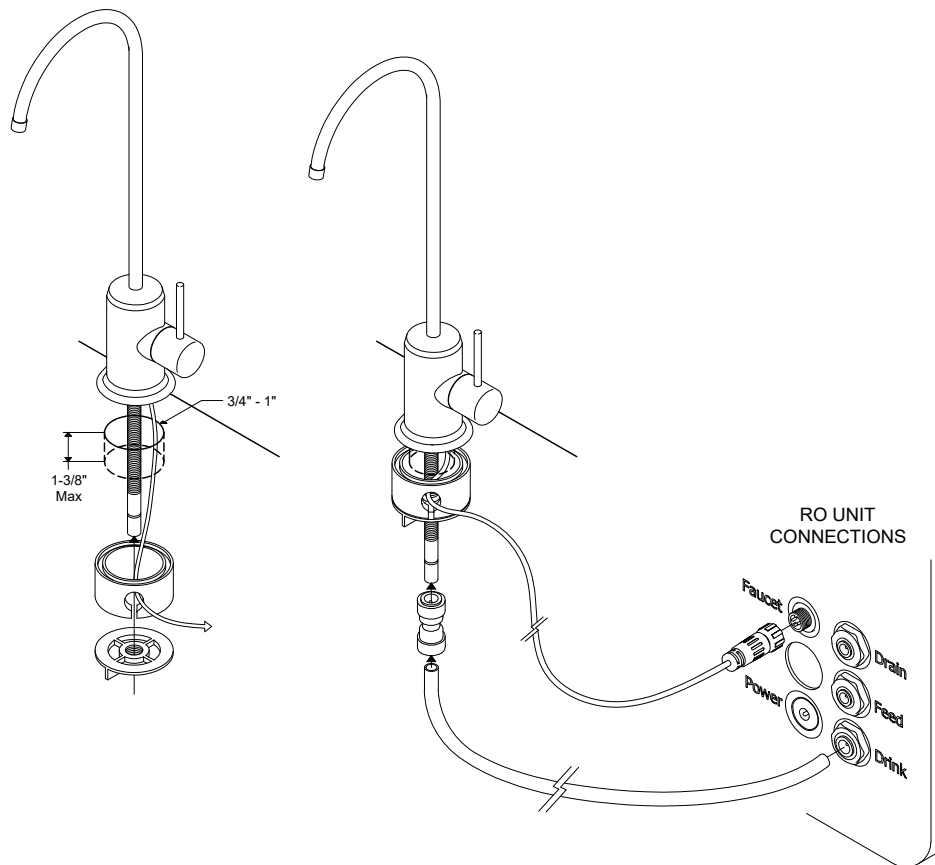

Faucet Installation - Drill a 3/4" hole for the stainless steel faucet and install, being sure that the faucet cable exits through the gap in the supplied spacer without being pinched.. Connect faucet cable to the FAUCET port on the RO System.

Drinking Water Port - Install the 3/8" push-connect faucet adapter onto the faucet stem. Connect one end of the 3/8" tubing to the faucet adapter and the other end to the RO System port marked 'DRINK'.

*

When installing your Reverse Osmosis filter, first set up your RO unit and allow it to make filtered water for 20 minutes before turning on your RO for the first time.

INSTALLATION INSTRUCTIONS



Cartridge Installation

*

Reverse Osmosis System **MUST** be placed on a flat, stable surface. Cartridges are installed from front.

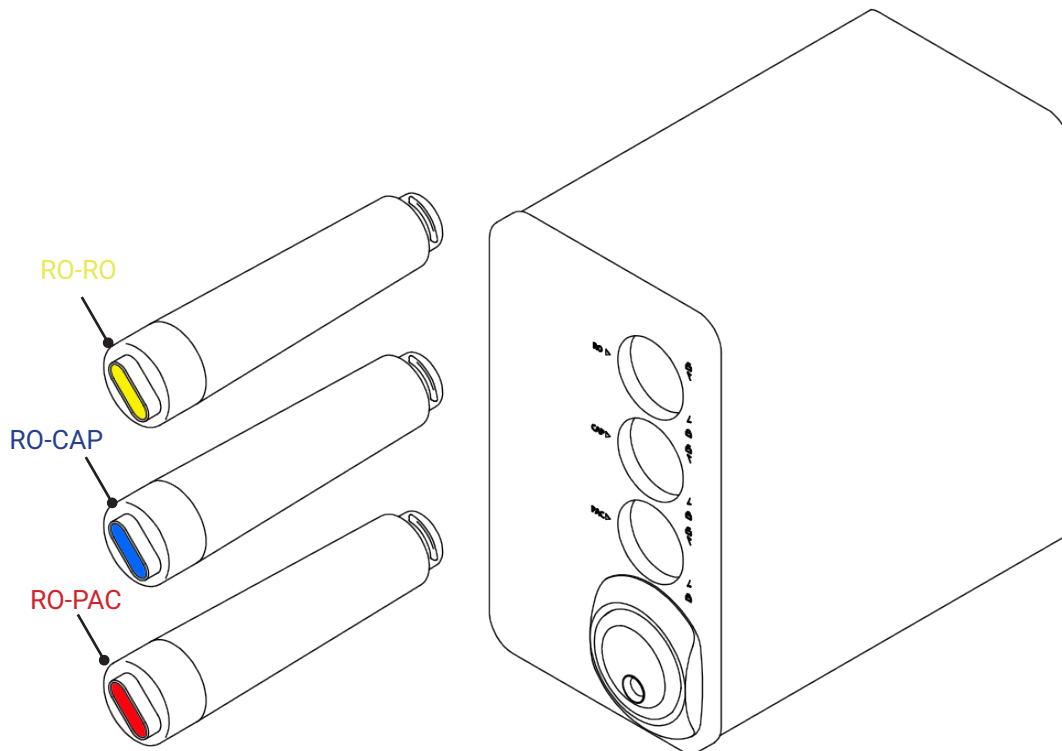

- Cartridges load in front of unit.
- Turn cartridge counter clockwise a 1/4 turn to remove old cartridge.
- Insert new cartridge and turn the cartridge clockwise a 1/4 turn to install.

INSTALLATION INSTRUCTIONS

Mineral Cartridge Installation

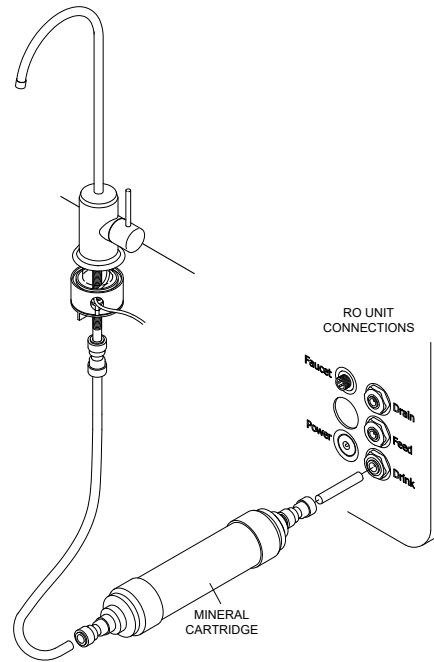

Mineral Cartridge Installation with RO Booster

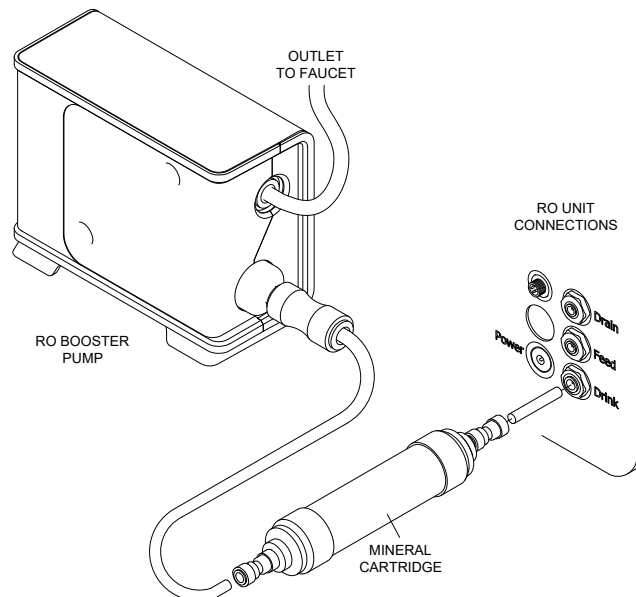

INSTALLATION INSTRUCTIONS



Cartridge Replacement

- When a cartridge is nearing depletion, the DROP system will send out a notification. Another notification will be sent when the cartridge is depleted. To replace a depleted cartridge, twist the cartridge from the lock to unlock position, then remove the cartridge. Install the new cartridge aligned with the unlock position then press and turn clockwise to the lock position. After physically replacing the cartridge, go to the RO Filter's status screen in the DROP Connect app and tap on the filter that you replaced to reset the usage remaining to 100%.

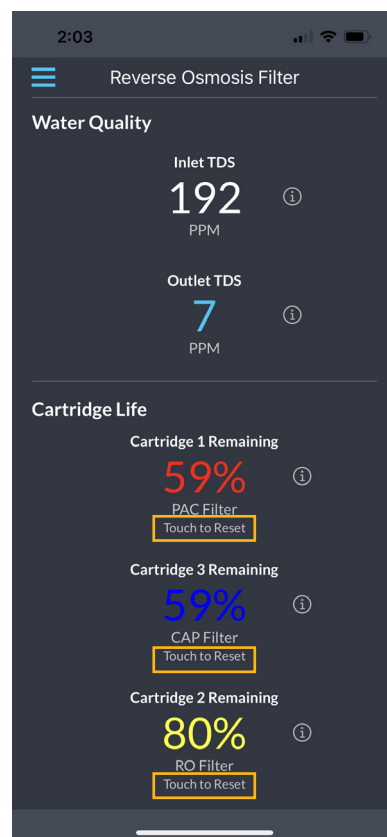

- The cartridge life will be different according to the area, water quality, season and working time. Please change them as indicated based on water quality and actual usage.
- Clean the exterior of the RO system using a damp cloth. Do not use strong detergents or volatile solvents like thinner, gasoline and alcohol, which could damage or discolor the enclosure.

INSTALL APP

If using the DROP RO with a DROP HUB, follow instructions below. If you are operating the DROP RO without a HUB, proceed to STAND ALONE MODE on page 15.

Download the DROP Connect Mobile (Required for HUB set up)



DROP Web App is available after the mobile set up is complete.



www.drop.io



If you wish to connect your system to local WiFi for and notifications, please install the DROP Hub in a location that has a good WiFi signal.

DROP APP



Follow Mobile Onboarding in the DROP Connect App

See Users Guide for detailed instructions

Reverse Osmosis System App Readings

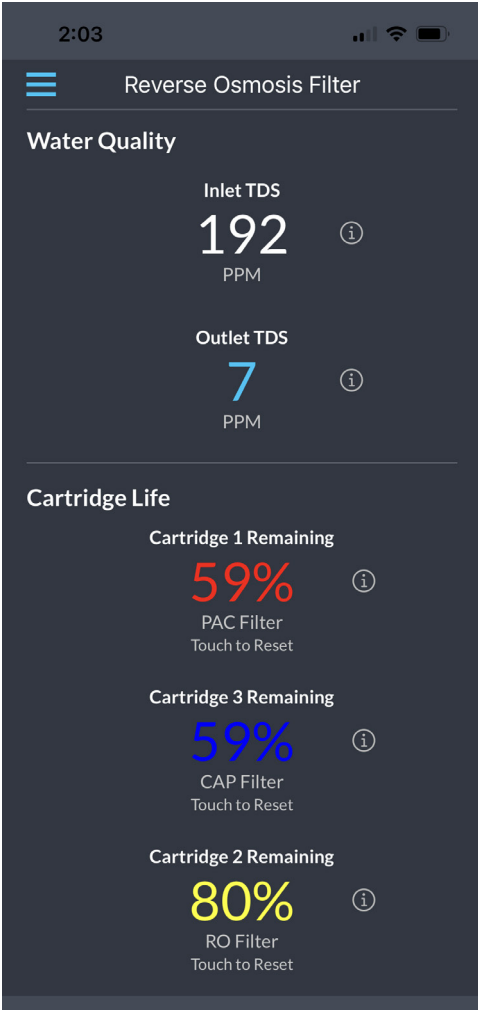

STAND ALONE MODE

The DROP Reverse Osmosis System is capable of purifying your water without a DROP Hub, however, **YOU WILL NOT** have the capability to monitor the system via the DROP App or receive any notifications from the system.

NOTE: To enable standalone mode hold the button on the front panel for 8 seconds and release the button when the upper lights turn purple. If you do not have a DROP Hub and the front panel is displaying red lights, you may need to enable standalone mode. Also, you may need to disable standalone mode if you later purchase a DROP hub.

In the STAND ALONE MODE, the front panel interface is used to monitor and control the system.

Front Panel Lights

- **Green:** The internal water tank is not empty.
- **Yellow:** The internal water tank is empty.

The center light will blink if any cartridge has less than 10% life remaining.

Cartridge Life Remaining

To view the amount of life remaining on each cartridge, touch the DROP logo button on the front panel. Each button press will advance to the next cartridge:

Red: PAC
Blue: CAP
Yellow: RO

While the upper lights display the color of the selected cartridge, the center light displays the amount of life remaining in the cartridge:

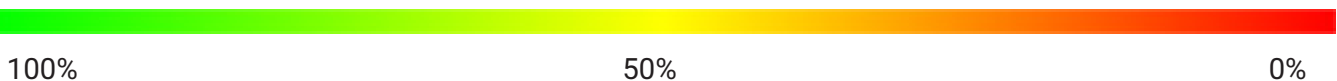

Resetting a Cartridge

To reset the life remaining for a cartridge, first select the cartridge by tapping the button as described above. Next, hold the button for 4 seconds until the selected cartridge color is again displayed and release the button.



WATER MANAGEMENT SYSTEMS

This warranty cannot be transferred - it is extended only to the original purchaser or first user of the product. By accepting and keeping this product, you agree to all of the warranty terms and limitations of liability described below.

Important Warning: Read carefully the DROP Water Management Systems Equipment Installation, Operating and Maintenance Instructions Manual to avoid serious personal injury and property HAZARDS and to ensure safe and proper care of this product.

*FOR AS LONG AS YOU OWN AND LIVE IN YOUR SINGLE FAMILY HOME, this warranty covers your water treatment equipment, if you are the first user of this DROP Water Treatment Systems equipment and purchased it for single family home use - subject to all of the conditions, limitations and exclusions listed below. Purchasers who buy the DROP equipment for other purposes, and other component parts are subject to more limited warranties and you should read all of the terms included in this form to make sure you understand your warranty.

What is covered by this warranty?

Chandler Systems, Inc. warrants that at the time of manufacture, the DROP equipment shall be free from defects in material and workmanship as follows:

Product	Warranty
Residential Mineral Tank	10 Years
DROP Control Valves	5 Years
DROP Pump Controllers	5 Years
DROP Home Protection Valve	5 Years
DROP Reverse Osmosis System	1 Year
DROP Booster Pump	1 Year
Brine Tank	5 Years
DROP Hub and Remote	1 Year
DROP Wireless Low Salt Alarm	1 Year
Other Accessories and Parts	1 Year
Brine Tank Components	1 Year

* This warranty does not include media and/or cartridge filter elements.

Additional Terms & Conditions

What Chandler Systems Inc will do if you have a covered warranty claim; Chandler Systems Inc will at its discretion either make repairs to correct any defect in material or workmanship or supply and ship either new or used replacement parts or products. Chandler Systems, Inc. will not accept any claims for labor or other costs.

Additional Exclusions and Limitations

This warranty is non-transferable and does not cover any failure or problem unless it was caused solely by a defect in material or workmanship. In addition, this warranty shall not apply:

- If the equipment is not correctly installed, operated, repaired and maintained as described in the Installation, Operating & Maintenance Instructions Manual provided with the product.
- Defects caused as a direct result of the incoming water quality

- If the DROP equipment is not sized appropriately for the intended job.
- To any failure or malfunction resulting from abuse (including freezing), improper or negligent; handling, shipping (by anyone other than DROP)
- If the unit has not always been operated within the factory recommended temperature limits, and at a water pressure not exceeding 125 psi, during storage, use, operation, accident; or alteration, lightning, flooding or other environmental conditions.
- To any failure or malfunction resulting from failure to operate the system with potable water, free to circulate at all times; and free of damaging water sediment or scale.
- This warranty does not cover labor costs, shipping charges, service charges, delivery expenses, property damage, administrative fees or any costs incurred by the purchaser in removing or reinstalling the water management equipment.
- The warranty does not cover any claims submitted more than 30 days after expiration of the applicable warranty, and does not apply unless prompt notice of any claim is given to an authorized DROP Dealer or to DROP or a designated contractor is provided access to the installation and to the water treatment equipment.

THESE WARRANTIES ARE GIVEN IN LIEU OF ALL OTHER EXPRESS WARRANTIES. NO DROP REPRESENTATIVE OR ANY OTHER PARTY IS AUTHORIZED TO MAKE ANY WARRANTY OTHER THAN THOSE EXPRESSLY CONTAINED IN THIS WARRANTY AGREEMENT.

Additional Warranty Limitations

ANY IMPLIED WARRANTIES THE PURCHASER MAY HAVE, INCLUDING THE IMPLIED WARRANTIES OF MERCHANTABILITY AND FITNESS FOR A PARTICULAR PURPOSE, SHALL NOT EXTEND BEYOND THE APPLICABLE TIME PERIODS SPECIFIED ABOVE. Some states do not allow limitations on how long an implied warranty lasts, so the above limitations may not apply to you.

Limitations of Remedies

The remedies contained in this warranty are the purchaser's exclusive remedies. In no circumstances will Chandler Systems, Inc. or the seller of the product be liable for more than, and purchaser-user's remedies shall not exceed, the price paid for the product. In no case shall Chandler Systems, Inc. or seller be liable for any special, incidental, contingent or consequential damages. Special, incidental, contingent and consequential damages for which Chandler Systems, Inc. is not liable include, but are not limited to, inconvenience, loss or damage to property, consequential mold damage, loss of profits, loss of savings or revenue, loss of use of the products or any associated equipment, facilities, buildings or services, downtime, and the claims of third parties including customers. Some states do not allow the exclusion or the limitation of incidental or consequential damages, so the above limitations or exclusion may not apply to you.

What to do if you have a problem covered by this warranty

Any warranty coverage must be authorized by Chandler Systems, Inc.. Contact the person from whom you purchased the product, who must receive authorization from a DROP Dealer.

If your product is new and not used and you wish to return it, contact your DROP Dealer.

Note: This equipment has been tested and found to comply with the limits for a Class B digital device, pursuant to part 15 of the FCC Rules. These limits are designed to provide reasonable protection against harmful interference in a residential installation. This equipment generates, uses and can radiate radio frequency energy and, if not installed and used in accordance with the instructions, may cause harmful interference to radio communications. However, there is no guarantee that interference will not occur in a particular installation. If this equipment does cause harmful interference to radio or television reception, which can be determined by turning the equipment off and on, the user is encouraged to try to correct the interference by one or more of the following measures:

- Reorient or relocate the receiving antenna.
- Increase the separation between the equipment and receiver.
- Connect the equipment into an outlet on a circuit different from that to which the receiver is connected.
- Consult the dealer or an experienced radio/TV technician for help.

Chandler Systems Inc.
710 Orange St.
Ashland, OH 44805

P. 1 833 BUY-DROP
www.dropconnect.com



