

# R1 – SERIES



R1 – 12140 PICTURED

## MEMBRANE SYSTEM USER MANUAL

This page is Intentionally  
left blank

# TABLE OF CONTENTS

INTRODUCTION.....	6
SAFETY .....	7
PRECAUTIONARY STATEMENTS.....	7
OPERATING DO'S AND DON'TS .....	8
FEEDWATER AND OPERATION SPECIFICATIONS.....	9
OPERATING LIMITS*.....	9
R1 – SERIES SYSTEM SPECIFICATION CHART .....	10
R1 – SERIES COMPONENT IDENTIFICATION DESCRIPTION .....	11
SOLENOID VALVE.....	13
PRE-FILTRATION .....	13
CONTROLLER .....	13
PRE-FILTER PRESSURE GAUGES.....	13
PUMP PRESSURE GAUGE.....	14
MEMBRANES.....	14
PERMEATE (PRODUCT) FLOW METER.....	14
CONCENTRATE (WASTE) FLOW METER .....	14
CONCENTRATE RECYCLE FLOW METER .....	14
PUMP.....	14
PUMP THROTTLE VALVE.....	15
ADJUSTING THE THROTTLE VALVE.....	15
LOW PRESSURE SWITCH.....	15
CHEMICAL INJECTION PORT .....	15
MEMBRANE INFORMATION .....	16
MEMBRANE ELEMENT SPECIFICATIONS .....	16
MEMBRANE PERFORMANCE .....	18
REJECTION.....	18
RECOVERY.....	18
SYSTEM INSTALLATION .....	19
MOUNTING .....	19
FEEDWATER CONNECTION .....	19
PERMEATE WATER (PRODUCT) CONNECTION .....	20
CONCENTRATE WATER (WASTE) CONNECTION.....	20
ELECTRICAL.....	21
LIQUID LEVEL (FLOAT) SWITCH .....	21
MEMBRANE INFORMATION AND HANDLING .....	22
MEMBRANE INSTALLATION/REPLACEMENT .....	23
SYSTEM PURGING / INITIAL START UP.....	25
FLUSHING THE SYSTEM.....	27
PREPARING UNIT FOR STORAGE .....	27
TEMPERATURE CORRECTION FACTORS FOR MEMBRANES .....	28

TEMPERATURE CORRECTION TABLE .....	29
REVERSE OSMOSIS SYSTEM OPERATION LOG .....	30
TROUBLESHOOTING CHART .....	31
TECHNICAL ASSISTANCE .....	31
S – 150 CONTROLLER SPECIFICATIONS AND INSTRUCTIONS .....	32
CONTROLLER SPECIFICATIONS .....	32
FRONT PANEL CONTROLS AND INDICATORS .....	33
INSTALLATION .....	34
PHYSICAL INSTALLATION .....	34
TERMINAL STRIP, JUMPER AND ADJUSTMENT LOCATIONS .....	34
POWER WIRING .....	34
PUMP AND VALVE RELAY OUTPUTS .....	34
RO PUMP WIRING .....	34
INLET AND FLUSH VALVE WIRING .....	34
TDS / CONDUCTIVITY CELL WIRING .....	34
SWITCH INPUTS .....	35
PRESSURE FAULT SWITCH .....	35
PRETREAT SWITCH .....	35
TANK FULL SWITCH .....	35
I/O EXPANDER BOARD .....	36
AUXILIARY PUMP .....	36
BOOST PUMP .....	36
DIVERT OUTPUT .....	36
ALARM OUTPUT .....	36
TANK LOW SWITCH .....	37
TERMINAL STRIP, JUMPER LOCATIONS .....	38
SAMPLE WIRING .....	39
EXPANDER BOARD TERMINAL STRIP, JUMPER LOCATIONS .....	40
TDS / CONDUCTIVITY CELL INSTALLATION .....	40
TO DISPLAY OR CHANGE SETPOINTS .....	42
SYSTEM OPERATION .....	42
GENERAL OPERATION .....	42
DISPLAY .....	42
OPERATING STATUS MESSAGES .....	42
TDS / CONDUCTIVITY .....	43
OPERATING HOURS .....	43
TEMPERATURE .....	43
WARNING MESSAGES .....	43
TANK FULL OPERATION .....	43
TANK FULL RESTART .....	44
TANK FULL OVERRIDE .....	44
PRESSURE FAULT .....	44

AUTO RESET .....	44
ALARM SILENCE .....	44
PRETREAT .....	44
MEMBRANE FLUSH .....	45
FLUSH MODE .....	45
HIGH TDS / CONDUCTIVITY WARNING / ALARM .....	46
OPERATING HOURS EXCEEDED .....	46
I/O EXPANDER .....	46
AUXILIARY OUTPUT .....	46
TANK LOW .....	46
BOOST PUMP OUTPUT .....	46
DIVERT OUTPUT .....	47
ALARM OUTPUT .....	47
ADJUSTMENTS .....	47
TDS / CONDUCTIVITY CALIBRATION .....	47
DISPLAY ADJUSTMENT .....	47
TROUBLESHOOTING .....	47
SYSTEM INOPERATIVE .....	47
DISPLAY BLANK .....	48
INLET VALVE WILL NOT OPERATE .....	48
RO PUMP WILL NOT OPERATE .....	48
UNIT NOT FLUSHING OR NOT FLUSHING CORRECTLY .....	48
NO OR INCORRECT TDS / CONDUCTIVITY READING .....	48
TDS / CONDUCTIVITY EXPANDER .....	48
INSTALLATION / WIRING .....	48
TDS / CONDUCTIVITY EXPANDER .....	49
SETPOINTS .....	49
OPERATION .....	50
CALIBRATION .....	50
MANUFACTURER'S DRAWINGS .....	51
R1 – 1140 FLOW DIAGRAM .....	51
R1 – 2140 FLOW DIAGRAM .....	52
R1 – 3140 FLOW DIAGRAM .....	53
R1 – 4140 FLOW DIAGRAM .....	54
R1 – 5140 FLOW DIAGRAM .....	55
R1 – 6140 FLOW DIAGRAM .....	56
R1 – 8140 FLOW DIAGRAM .....	57
R1 – 10140 FLOW DIAGRAM .....	58
R1 – 12140 FLOW DIAGRAM .....	58
SYSTEM WARRANTY .....	60

## INTRODUCTION

The R1 Series Reverse Osmosis Systems are state-of-the-art, versatile systems for treating tap and well water supplies with minimal energy consumption and low maintenance and operational costs. R1 – Series systems feature a robust, innovative design that allows for versatility in the event of feedwater quality and temperature variations. Your R1 – Series system is a durable piece of equipment which, with proper care, will last for many years. Standard features include a concentrate recycle loop with flowmeter, chemical injection port with power outlet, and permeate TDS monitoring. All R1 – Series systems feature high quality parts and components for enhanced performance and reliability including HF5 ultra low energy membranes, FRP Series – Fiberglass membrane housings, pressure gauges, flow meters, filter housings, and cartridges.

This User's Manual outlines installation, operation, maintenance and troubleshooting details vital to the sustained performance of your system. The test information which is included with this User's Manual, documents your system's performance during our rigorous three stage testing and inspection process.

**DO NOT UNDER ANY CIRCUMSTANCE REMOVE ANY CAUTION, WARNING, OR OTHER DESCRIPTIVE LABELS FROM THE SYSTEM.**

**PRIOR TO OPERATING OR SERVICING THE REVERSE OSMOSIS SYSTEM, THIS USER'S MANUAL MUST BE READ AND FULLY UNDERSTOOD. KEEP THIS AND OTHER ASSOCIATED INFORMATION NEAR THE SYSTEM FOR FUTURE REFERENCE.**

**IN ORDER TO MAINTAIN THE MANUFACTURER'S WARRANTY, AN OPERATING LOG MUST BE MAINTAINED. COPIES WILL NEED TO BE SENT TO YOUR LOCAL DEALER OR DISTRIBUTOR FOR REVIEW IN THE EVENT OF A WARRANTEE COVERAGE ISSUE.**

## SAFETY

Defined below are the three safety headings used throughout this User Manual's text.



**WARNING: INDICATES STATEMENTS THAT ARE USED TO IDENTIFY DANGEROUS CONDITIONS OR PRACTICES. FAILURE TO FOLLOW WARNINGS COULD RESULT IN SERIOUS INJURY OR DEATH.**



**CAUTION: INDICATES STATEMENTS THAT ARE USED TO IDENTIFY CONDITIONS OR PRACTICES THAT COULD RESULT IN EQUIPMENT OR OTHER PROPERTY DAMAGE**



**ELECTRICAL HAZARD: INDICATES STATEMENTS THAT ARE USED TO IDENTIFY HIGH - VOLTAGE AND POTENTIAL SHOCK/ ELECTROCUTION.**

**STATEMENTS IN BOLD AND ALL CAPITALS ARE ADVISORY OR INFORMATIONAL STATEMENTS OF PARTICULAR IMPORTANCE TO THE HEADING UNDER WHICH THEY ARE FOUND.**

### PRECAUTIONARY STATEMENTS



**DO NOT USE WHERE THE WATER IS MICROBIOLOGICALLY UNSAFE OR OF UNKNOWN QUALITY WITHOUT ADEQUATE DISINFECTION BEFORE OR AFTER THE SYSTEM.**



**ALWAYS TURN OFF THE UNIT, SHUT OFF THE FEEDWATER, RELIEVE PRESSURE, AND DISCONNECT THE ELECTRICAL POWER BEFORE WORKING ON THE UNIT.**



**PRE-TREATMENT MUST BE SUFFICIENT TO ELIMINATE CHEMICALS, ORGANICS OR INORGANICS THAT COULD ATTACK THE MEMBRANE MATERIAL.**



**DO NOT OPERATE THE SYSTEM WITH INSUFFICIENT FEED FLOW. NEVER ALLOW THE PUMP TO RUN DRY.**



**NEVER ALLOW THE UNIT TO FREEZE OR OPERATE WITH A FEEDWATER TEMPERATURE ABOVE 85°F.**



**DO NOT PERMIT CHLORINE TO BE PRESENT IN THE FEEDWATER.**



**DO NOT SHUT DOWN THE SYSTEM FOR EXTENDED PERIODS. IT IS BEST TO RUN THE SYSTEM AS MUCH AS POSSIBLE ON A CONTINUOUS BASIS.**



**DO NOT CLOSE THE CONCENTRATE VALVE COMPLETELY.**



**DO NOT CLOSE THE PUMP THROTTLE VALVE COMPLETELY.**



**ELECTRICAL INSTALLATION SHOULD BE DONE BY QUALIFIED, TRAINED ELECTRICIANS. INSTALLATION SHOULD BE TO LOCAL CODES.**

## OPERATING DO'S AND DON'TS

### DO

- Change the cartridge filters regularly.
- Monitor the system and keep a daily log.
- Run the system as much as possible on a continuous basis.
- Always feed the pump with filtered water.



### DON'T

- Permit chlorine to enter or be present in the feedwater.
- Shut down the system for extended periods.
- Operate the system with insufficient feed flow or pressure.
- Operate the pump dry.





## FEEDWATER AND OPERATION SPECIFICATIONS

Nothing has a greater effect on a reverse osmosis system than the feedwater quality. If your system is altered at the site of operation or if the feedwater conditions change, please contact your local dealer or distributor to determine the proper recovery for your application. Before starting the RO system it is strongly suggested to obtain an up to date water analysis of the water to be treated.



**IT IS VERY IMPORTANT TO MEET THE MINIMUM FEEDWATER AND OPERATING REQUIREMENTS OUTLINED IN THIS MANUAL. NOT DOING SO WILL CAUSE DAMAGE OR FAILURE OF THE SYSTEM COMPONENTS AND MEMBRANES. DAMAGE TO THE SYSTEM DUE TO OPERATION OUTSIDE OF THE SPECIFICATIONS OUTLINED IN THIS MANUAL WILL VOID THE MANUFACTURERS WARRANTY. CHECK YOUR FEEDWATER CHEMISTRY AND, IF NECESSARY, CONSULT WITH YOUR LOCAL DEALER OR DISTRIBUTOR BEFORE START UP OF THE SYSTEM.**

### OPERATING LIMITS\*

Design Temperature, °F	77	Maximum Turbidity, NTU	1
Maximum Feed Temperature, °F	85	Maximum Free Chlorine, ppm	0
Minimum Feed Temperature, °F	40 <sup>†</sup>	Maximum TDS, ppm	2,000 <sup>†</sup>
Maximum Ambient Temperature, °F	120	Maximum Hardness, gpg	0
Minimum Ambient Temperature, °F	40	Maximum pH (continuous)	10
Maximum Feed Pressure, PSI	85	Minimum pH (continuous)	4
Minimum Feed Pressure, PSI	45	Maximum pH (cleaning 30 minutes)	12
Maximum Operating Pressure, PSI	200	Minimum pH (cleaning 30 minutes)	2
Maximum SDI Rating	<3		

<sup>†</sup>Low temperatures and feedwater quality, such as high TDS levels will significantly affect the systems production capabilities and performance. Computer projections must be run for individual applications which do not meet or exceed minimum and maximum operating limits for such conditions.

\*If any of the feedwater parameters are not within the limits given, consult your local dealer or distributor for assistance.



**HIGHER TDS AND/OR LOWER TEMPERATURES WILL REDUCE THE SYSTEM'S PRODUCTION.**

# R1 – SERIES SYSTEM SPECIFICATION CHART

MODELS	R1 – 1140	R1 – 2140	R1 – 3140	R1 – 4140	R1 – 5140	R1 – 6140	R1 – 8140	R1 – 10140	R1 – 12140
<b>Flow Rates<sup>††</sup></b>									
Permeate Flow Rate (gpd)	1,800	3,600	5,400	7,200	9,000	10,800	14,400	18,000	21,600
Permeate Flow Rate (gpm)	1.25	2.50	3.75	5.00	6.25	7.50	10.00	12.50	15.00
Feedwater <sup>†</sup> TDS Max (ppm)	2,000	2,000	2,000	2,000	2,000	2,000	2,000	2,000	2,000
Standard Recovery (%)	29	45	56	63	68	56	63	68	71
Minimum Concentrate Flow Rate (gpm)	3	3	3	3	3	6	6	6	6
Concentrate Recycle Flow Rate (gpm)	Up to 5	Up to 5	Up to 5	Up to 5	Up to 5	Up to 5	Up to 5	Up to 5	Up to 5
<b>Connections</b>									
Feed	1" FNPT	1" FNPT	1" FNPT	1" FNPT	1" FNPT	1" FNPT	1" FNPT	1" FNPT	1" FNPT
Permeate	3/4" FNPT	3/4" FNPT	3/4" FNPT	1" FNPT	1" FNPT	1" FNPT	1" FNPT	1" FNPT	1" FNPT
Concentrate	3/4" FNPT	3/4" FNPT	3/4" FNPT	1" FNPT	1" FNPT	1" FNPT	1" FNPT	1" FNPT	1" FNPT
<b>Membranes</b>									
Membrane(s) Per Vessel	1	1	1	1	1	1	1	1	1
Membrane Quantity	1	2	3	4	5	6	8	10	12
Membrane Size	4040	4040	4040	4040	4040	4040	4040	4040	4040
Nominal TDS Rejection (%)	98.5	98.5	98.5	98.5	98.5	98.5	98.5	98.5	98.5
<b>Vessels</b>									
Vessel Array	1	1:1	1:1:1	1:1:1:1	1:1:1:1:1	2:2:2	2:2:2:2	2:2:2:2:2	2:2:2:2:2:2
Vessel Quantity	1	2	3	4	5	6	8	10	12
<b>Standard Pump</b>									
Pump Type	Multi-Stage	Multi-Stage	Multi-Stage	Multi-Stage	Multi-Stage	Multi-Stage	Multi-Stage	Multi-Stage	Multi-Stage
Motor HP	1.5	1.5	1.5	1.5	3	3	3	3	3
RPM at 60	3450	3450	3450	3450	3450	3450	3450	3450	3450
Standard Voltage + Amp Draw	220V 60HZ 1PH 8.8A	220V 60HZ 1PH 8.8A	220V 60HZ 1PH 8.8A	220V 60HZ 1PH 8.8A	220V 60HZ 3PH 16A	220V 60HZ 3PH 16A	220V 60HZ 3PH 16A	220V 60HZ 1PH 16A	220V 60HZ 3PH 16A
<b>System Dimensions</b>									
Approximate Dimensions L x W x H <sup>†††</sup>	26" x 26" x 60"	26" x 26" x 60"	26" x 26" x 60"	26" x 26" x 60"	26" x 26" x 60"	32" x 26" x 60"	32" x 50" x 60"	32" x 50" x 60"	32" x 50" x 60"
Approximate Weight <sup>††††</sup>	250 lbs.	290 lbs.	330 lbs.	370 lbs.	430 lbs.	470 lbs.	510 lbs.	550 lbs.	590 lbs.

<sup>††</sup> Product flow and maximum recovery rates are based on feedwater conditions as stated above. Do not exceed recommended permeate flow.

<sup>†††</sup> Does not include operating space requirements.

<sup>††††</sup> Does not include membrane.

**Warranty Evaluation Test Conditions:** Permeate flow rates and salt rejection based on the following test conditions – 550 ppm, filtered and dechlorinated municipal tap water, 77°F / 25°C, 15% recovery, 7.0 pH and the specified operating pressure for membrane element type. Data taken after 60 minutes of operation.

# R1 – SERIES COMPONENT IDENTIFICATION DESCRIPTION

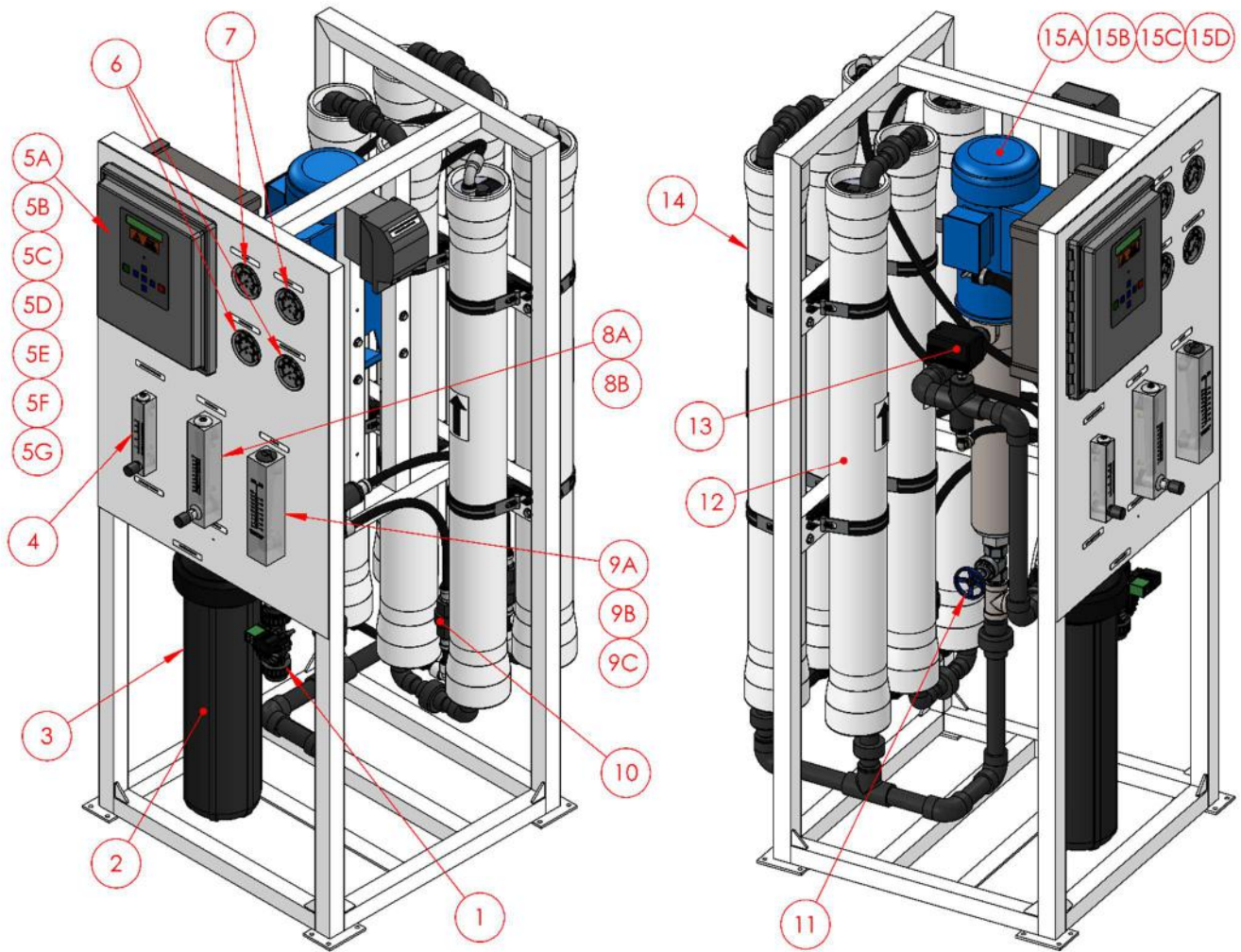

\* (10B) IS LOCATED BEHIND THE FRONT PANEL ATTACHED TO THE PERMEATE FLOW METER FOR R1 MODELS 1140-5140

ITEM NUMBER	PART NUMBER	DESCRIPTION	MODEL(s)
1	207475	VALVE, SOLENOID, 2-WAY, COMPOSITE, 220V, 1"FNPT, ASCO	R1 1140 – 12140
2	200640	CARTRIDGE, SEDIMENT, POLYPRO, 4.5" X 20", 5 MIC, SDF-45-2005, AXEON	R1 1140 – 12140
3	207290	HOUSING, FILTER, BLK/GRY, 4.5" X 20", SGL O-RING, NPR, 1" FNPT, AXEON	R1 1140 – 12140
4	205104	METER, FLOW, PM, 1-5 GPM, SS VALVE, 1/2" MNPT X 1/2" MNPT, AXEON	R1 1140 – 12140
5A	206350	CONTROLLER, COMPUTER, S-150, 220V, 1PH, 12 X 10 BOX	R1 1140 – 12140
5B	207730	CONTROLLER, COMPUTER, S-150, 220V, 3PH, 1.5HP, 12 X 10 BOX	R1 1140 - 4140 (220V)
5C	203261	CONTROLLER, COMPUTER, S-150, 380V, 3PH, 3 HP, 12X10 BOX	R1 5140 – 12140 (380V)
5D	202848	CONTROLLER, COMPUTER, S-150, 460V, 3PH, 1 - 1.5 HP, 12X10	R1 1140 – 4140 (460V)
5E	203260	CONTROLLER, COMPUTER, S-150, 220V, 3PH, 3 HP, 12X10 BOX	R1 5140 – 12140 (220V)
5F	203262	CONTROLLER, COMPUTER, S-150, 460V, 3PH, 3 HP, 12X10 BOX	R1 6140 – 12140 (460V)
5G	203259	CONTROLLER, COMPUTER, S-150, 380V, 3PH, 1 - 1.5 HP, 12X10 BOX	R1 1140 – 4140
6	200904	GAUGE, PM, GLY FILL, 0-300 PSI/BAR, 2.5" DIA, 1/4" MNPT, AXEON	R1 1140 – 12140
7	204165	GAUGE, PM, GLY FILL, 0-100 PSI/BAR, 2.5" DIA, 1/4" MNPT, AXEON	R1 1140 – 12140
8A	205105	METER, FLOW, PM, 1-10 GPM, SS VALVE, 1" MNPT X 1" MNPT, AXEON	R1 4140 – 12140
8B	205104	METER, FLOW, PM, 1-5 GPM, SS VALVE, 1/2" MNPT X 1/2" MNPT, AXEON	R1 1140 – 3140
9A	200899	METER, FLOW, PM, 1-10 GPM, 1" MNPT x 1" MNPT, AXEON	R1 4140 – 5140
9B	200900	METER, FLOW, PM, 2-20 GPM, 1" MNPT x 1" MNPT, AXEON	R1 6140 – 12140
9C	200898	METER, FLOW, PM, 1-5 GPM, 1/2" MNPT x 1/2" MNPT, AXEON	R1 1140 – 3140
10	200966	VALVE, CHECK, PVC, 3/4" FNPT X 3/4" FNPT	R1 6140 – 12140
10B	200965	VALVE, CHECK, PVC, 1/2" FNPT X 1/2" FNPT	R1 1140 – 5140
11	200995	VALVE, GLOBE, SS, 1" FNPT	R1 1140 – 12140
12	200394	MEMBRANE, HF5, 4040, DRY, AXEON	R1 1140 – 12140
13	200906	SWITCH, PRESSURE, LOW, N/O, 15-30 PSI, 1/4" FNPT	R1 1140 – 12140
14	208419	HOUSING, MEMBRANE, FRP-300E, 4040, 1/2" P X 3/4" C FNPT, AXEON	R1 1140 – 12140
15A	200795	PUMP, MULTI-STAGE, 1.5 HP, 110/220V 1 PH, 10GBS1514Q4, GOULDS	R1 1140 – 4140
15B	200798	PUMP, MULTI-STAGE, 3 HP, 220V 1 PH, 25GBS3014P4, GOULDS	R1 5140 – 12140
15C	200799	PUMP, MULTI-STAGE, 3 HP, 220/460V 3 PH, 25GBS3017P4, GOULDS	R1 5140 – 12140
15D	203248	PUMP, MULTI-STAGE, 1.5 HP, 220/460V 3 PH, 10GBS1517Q4, GOULDS	R1 1140 – 4140

## SOLENOID VALVE

System inlet valve. Opens when system is in operation, closes when product tank is full or system is in non-operational mode.



## PRE-FILTRATION

R1 – Series systems are supplied with a 5 micron sediment filter. Change the cartridge often or when a 10 - 15 psi differential exists between the filter in and filter out pressure.



**THE SYSTEM MUST BE OPERATED ON FILTERED WATER ONLY.**

## CONTROLLER

The R1 – Series systems come standard with an S – 150 Controller. The S – 150 Series controller is a state of the art, microprocessor controlled system for commercial and industrial reverse osmosis. The S – 150 includes numerous standard features such as pressure switch control, motor contactor, TDS / Conductivity monitor with programmable setpoints, pretreatment lock out, tank level switch controls, flush valve control, programmable membrane flush type and mode, optional I/O expander board, and optional dual TDS expander board. The S – 150 Series controller displays system, sensor, and switch input status on an easy to read 2 line x 20-character backlit liquid crystal display. User programmable setpoints allow fast and easy adjustment of system parameters.



## PRE-FILTER PRESSURE GAUGES

These gauges measure the feedwater pressure when it enters and exits the pre-filter. A pressure differential of 10 - 15 psi or more between the two pressure gauges indicates that the pre-filters require replacement.

EXAMPLE: If the inlet pressure is 40 psi, the filter should be changed when the outlet pressure is 25 - 30 psi or below.



FILTER IN



FILTER OUT

## PUMP PRESSURE GAUGE

The pump pressure gauge measures the pressure of the water as it exists the pump to enter the membrane in the system.

## MEMBRANES

R1 – Series systems come standard with HF5 membranes. Membranes separate impurities from water through the reverse osmosis process. See Membrane Information and Handling section of this manual for additional information.

## PERMEATE (PRODUCT) FLOW METER

The permeate flow meter measures the amount of product water the system is producing as gallons/liters per minute.

## CONCENTRATE (WASTE) FLOW METER

The concentrate pressure gauge measures the pressure of the concentrate water as it exits the last membrane of the system. Subtracting the concentrate pressure from the pump pressure will give the pressure drop across the membrane array.

## CONCENTRATE RECYCLE FLOW METER

The concentrate recycle flow meter is equipped with a needle valve to control the amount of concentrate water being recycled through the system. Water that would normally go down the drain as waste is diverted back into the system before the pump for reprocessing, thus increasing the system's percent of recovery. The concentrate recycle flow meter measures the amount of water the system is recycling as gallons/liters per minute.



**RECYCLING CONCENTRATE WATER WILL INCREASE THE DISSOLVED SOLIDS IN THE WATER BEING PROCESSED BY THE MEMBRANES THUS AFFECTING THE PERMEATE QUALITY. EXCESSIVE RECYCLING MAY CAUSE PREMATURE FOULING OR SCALING OF THE MEMBRANE ELEMENTS.**

## PUMP

The R1 – Series systems use a multi-stage centrifugal stainless steel pump. If any damage occurs to your system's pump, a re-build kit may be available. Contact your local dealer or distributor and inform them of your system and pump model.



**NEVER RUN PUMP DRY. OPERATING PUMP WITHOUT SUFFICIENT FEED FLOW WILL CAUSE DAMAGE OR FAILURE.**

## PUMP THROTTLE VALVE

The pump throttle valve is installed as a standard feature on the R1 – Series Reverse Osmosis Systems. It provides an adjustment for pump pressure. As the feedwater temperature decreases, and/or the feedwater TDS increases, the system will require a higher operating pressure to produce the specified permeate flow.

### ADJUSTING THE THROTTLE VALVE

To decrease the pressure, turn the handle clockwise.  
To increase the pressure, turn the handle counter clockwise.

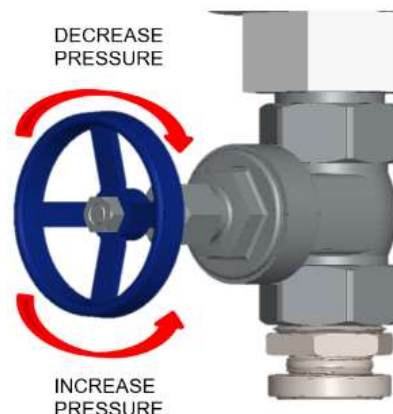

### LOW PRESSURE SWITCH

The low pressure switch shuts off the system when the feedwater pressure drops below 15 PSI, preventing damage to the pump. The system restarts automatically when there is a constant pressure of 35 PSI or more.



**IF THE SYSTEM PRESSURE IS FLUCTUATING, AND THE SYSTEM CYCLING OFF AND ON, TURN THE SYSTEM OFF AND ENSURE THAT PROPER FEEDWATER FLOW AND PRESSURE ARE BEING SUPPLIED TO THE SYSTEM.**

### CHEMICAL INJECTION PORT

The chemical injection port is to be used with an optional chemical injection system. The 1/2" PVC plug located on the pump inlet manifold, pictured here, should be removed and a chemical injector should be installed in its place.

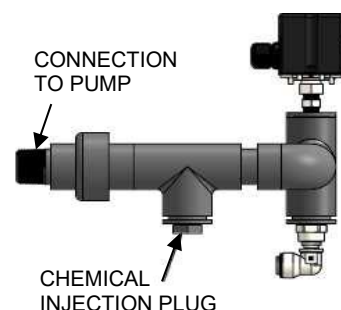

**R1 – SERIES SYSTEMS COME STANDARD WITH A CHEMICAL INJECTION ELECTRICAL OUTLET. THIS OUTLET IS INTENDED ONLY FOR CHEMICAL INJECTION PUMPS. DO NOT USE THIS OUTLET FOR ANYTHING OTHER THAN ITS INTENDED PURPOSE. DO NOT EXCEED 5 AMPS.**



**IF THE SYSTEM HAS ANTISCALANTS OR ANTIFOULANTS INJECTED ALONG WITH A BLEND VALVE OPTION, AND IF THE PERMEATE WATER IS USED AS POTABLE WATER, THE SYSTEM MUST HAVE A POTABLE/LOW PRESSURE BLEND VALVE OPTION. THIS IS TO AVOID INJECTION OF ANY CHEMICALS. THE POTABLE/LOW PRESSURE WATER BLEND OPTION ISOLATES THE CHEMICALS FROM DIRECT INJECTION INTO THE PRODUCT WATER. CONTACT YOUR DEALER OR DISTRIBUTOR FOR MORE INFORMATION.**

## MEMBRANE INFORMATION

R1 – Series reverse osmosis systems come pre-loaded with HF5 Ultra Low Energy membranes. General membrane element performance characteristics are listed on the following membrane specification chart.

### MEMBRANE ELEMENT SPECIFICATIONS

#### HF5 – Ultra Low Energy Membranes (Standard)

- **Membrane Type:** Polyamide Thin – Film Composite
- **Maximum Operating Temperature:** 113°F (45°C)
- **Maximum Operating Pressure:** 400 psi (27.58 bar)
- **pH Range, Continuous Operation\*:** 2 – 11
- **pH Range, Short Term Cleaning (30 Min.):** 1 – 13
- **Maximum Feed Silt Density Index (SDI):** 5
- **Chlorine Tolerance:** 0 ppm
- **Maximum Feed Flow Rate (gpm):** 2.5" = 6; 4.0" = 14

\*Maximum temperature for continuous operations above pH10 is 95°F (35°C).

Product Specifications				Dimensions inch / mm			
Part Number	Description	Applied Pressure psi / bar	Permeate Flow Rate gpd / m <sup>3</sup> /d	A	B	C	D
<b>200394</b>	HF5 – 4040	80 / 5.40	2500 / 9.46	40 / 1016.00	1.10 / 27.94	0.75 / 19.05	3.95 / 100.30

**Warranty Evaluation Test Conditions:** Permeate flow and salt rejection based on the following test conditions – 550 ppm, filtered and dechlorinated municipal tap water, 77°F / 25°C, 15% recovery and the specified operating pressure. Minimum salt rejection is 96%. Permeate flows for warranty evaluation may vary +/-20%. Maximum pressure drop at 13 psig / 0.9 bar.

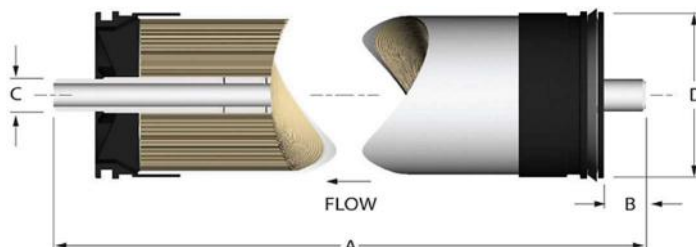

All 4040 elements fit nominal 4.00" I.D. membrane housings.

Proper start – up of reverse osmosis water treatment systems is essential to prepare the membranes for operating service and to prevent membrane damage due to overfeeding or hydraulic shock. Before initiating system start – up procedures, membrane pretreatment, loading of the membrane elements, instrument calibration and other system checks should be completed.

Avoid any abrupt pressure or cross – flow variations on the spiral elements during start – up, shutdown, cleaning or other sequences to prevent possible membrane damage. During start – up, a gradual change from a standstill to operating state is recommended as follows:

- Feed pressure should be increased gradually over a 30 – 60 second time frame.
- Cross – flow velocity at set operating point should be achieved gradually over 15 – 20 seconds.
- Permeate obtained from first hour of operation should be discarded.
- Maximum pressure drop across an entire pressure vessel (housing) is 30 psi / 2.1 bar.
- Avoid static permeate – side backpressure at all times.

Under certain conditions, the presence of free chlorine, chloramines and other oxidizing agents will cause premature membrane failure. Since oxidation damage is not covered under warranty, the manufacturer recommends removing all oxidizing agents by pretreatment prior to membrane exposure. Please contact the manufacturer or your supplier for more information.



Do not use this initial permeate for drinking water or food preparation. Keep elements moist at all times after initial wetting. To prevent biological growth during prolonged system shutdowns, it is recommended that membrane elements be immersed in a preservative solution. Rinse out the preservative before use. For membrane warranty details, please contact the manufacturer or your supplier for more information.

If operating limits and guidelines given in this product specification sheet are not strictly followed, the warranty will be null and void. The customer is fully responsible for the effects of incompatible chemicals and lubricants on elements. Use of any such chemicals or lubricants will void the warranty. These membranes may be subject to drinking water application restrictions in some countries: please check the application status before use and sale. The use of this product in and of itself does not necessarily guarantee the removal of cysts and pathogens from water. Effective cyst and pathogen reduction is dependent on the complete system design and on the operation and maintenance of the system.

No freedom from infringement of any patent owned by the manufacturer or others is to be inferred. Because use conditions and applicable laws may differ from one location to another and may change with time, customer is responsible for determining whether products and the information in this document are appropriate for customer's use and for ensuring that customer's workplace and disposal practices are in compliance with applicable laws and other governmental enactments. The claims made may not have been approved for use in all countries. The manufacturer assumes no obligation or liability for the information in this document. **NO WARRANTIES ARE GIVEN; ALL IMPLIED WARRANTIES OF MERCHANTABILITY OR FITNESS FOR A PARTICULAR PURPOSE ARE EXPRESSLY EXCLUDED.**

## MEMBRANE PERFORMANCE

R1 – Series reverse osmosis systems are designed to produce a nominal of 1,800 GPD of permeate water per membrane at 98.5% rejection under the proper conditions. For example, the R1 – 5140 produces a nominal of 9,000 gallons per day of permeate water at the listed operating test conditions.

### REJECTION

The amount of total dissolved solids (TDS) rejected by the membrane is expressed as a percentage. R1 – Series reverse osmosis systems are designed to reject up to 98.5% NaCl depending on feedwater chemistry. A 98.5% rejection rate means that 98.5% of total dissolved solids do not pass through the membrane. To calculate the percent of rejection, use the following formula:

$$\% \text{ REJECTION} = \frac{\text{FEED TDS} - \text{PERMEATE TDS}}{\text{FEED TDS}} \times 100$$

Example:

$$\frac{550 \text{ TDS} - 8.25 \text{ TDS}}{550 \text{ TDS}} \times 100 = 98.5\% \text{ REJECTION}$$

### RECOVERY

The amount of permeate water recovered for use is expressed as a percentage. To calculate percent of recovery, use the following formula:

$$\% \text{ RECOVERY} = \frac{\text{PRODUCT WATER FLOW RATE}}{\text{FEEDWATER FLOW RATE}} \times 100$$

Example:

$$\frac{6.5 \text{ GPM}}{9.5 \text{ GPM}} \times 100 = 68\% \text{ RECOVERY}$$



**ALL FLOW RATES MUST BE EXPRESSED IN THE SAME UNITS, TYPICALLY GALLONS PER MINUTE (GPM).**

# SYSTEM INSTALLATION

## MOUNTING

When choosing a location to install the system, select an area with enough head room to remove the membranes and easily access components and connections. Make sure there is enough room for service to be performed on the system. Take into consideration where your electrical power supply is located and where the nearest drain is located. Do not install system in direct sunlight or subject the system to temperature extremes (see operating limits chart pg. 9) and/or excess humidity.

The R1 – Series System should be secured in compliance with state and local regulations.

## FEEDWATER CONNECTION

Attach the water supply plumbing to the 1" FNPT solenoid valve labeled "FEED".



**R1 – SERIES SYSTEMS MUST HAVE A FEEDWATER LINE TO THE SYSTEM NO LESS THAN 1". USING SMALLER LINE SIZES WILL CAUSE DAMAGE TO THE SYSTEM'S PUMP.**

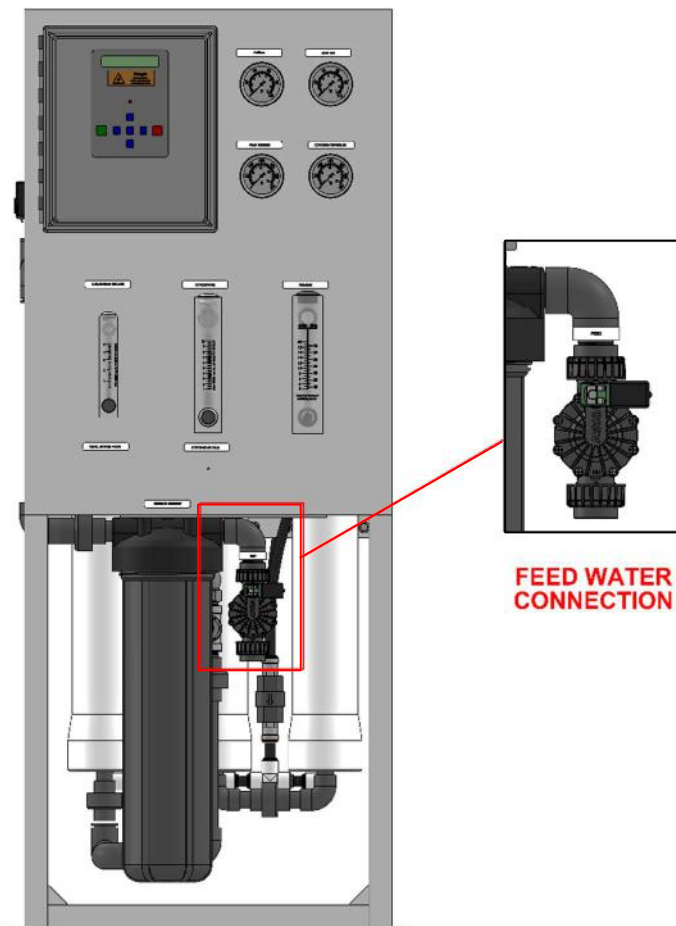

## PERMEATE WATER (PRODUCT) CONNECTION

Locate the 3/4" (R1 – 1140 to R1 – 3140) or 1" (R1 – 4140 to R1 – 12140) union on the outlet of the permeate flow meter labeled "PERMEATE", and run plumbing to a storage tank.



**ENSURE THAT THE PERMEATE WATER CAN FLOW FREELY WITH NO BACK PRESSURE. BACK PRESSURE CAN CAUSE IRREVERSABLE DAMAGE TO THE MEMBRANES.**



**THE PH OF THE REVERSE OSMOSIS PERMEATE WATER WILL TYPICALLY BE 1-2 POINTS LOWER THAN THE FEEDWATER PH. A LOW PH CAN BE VERY AGGRESSIVE TO SOME PLUMBING MATERIALS SUCH AS COPPER PIPING. PERMEATE WATER MAY CORRODE OR LEECH IMPURITIES FROM MANY COMMON PLUMBING MATERIALS. THE PERMEATE LINE SHOULD BE RUN TO A STORAGE TANK USING FDA APPROVED MATERIALS FOR PURIFIED WATER.**

## CONCENTRATE WATER (WASTE) CONNECTION.

Locate the 3/4" (R1 – 1140 to R1 – 3140) or 1" (R1 – 4140 to R1 – 12140) union on the outlet of the concentrate flow meter labeled "CONCENTRATE", and run plumbing to a drain. It is advised that an air-break be used on the concentrate line to prevent siphoning of water from the pressure vessels when the system is in standby

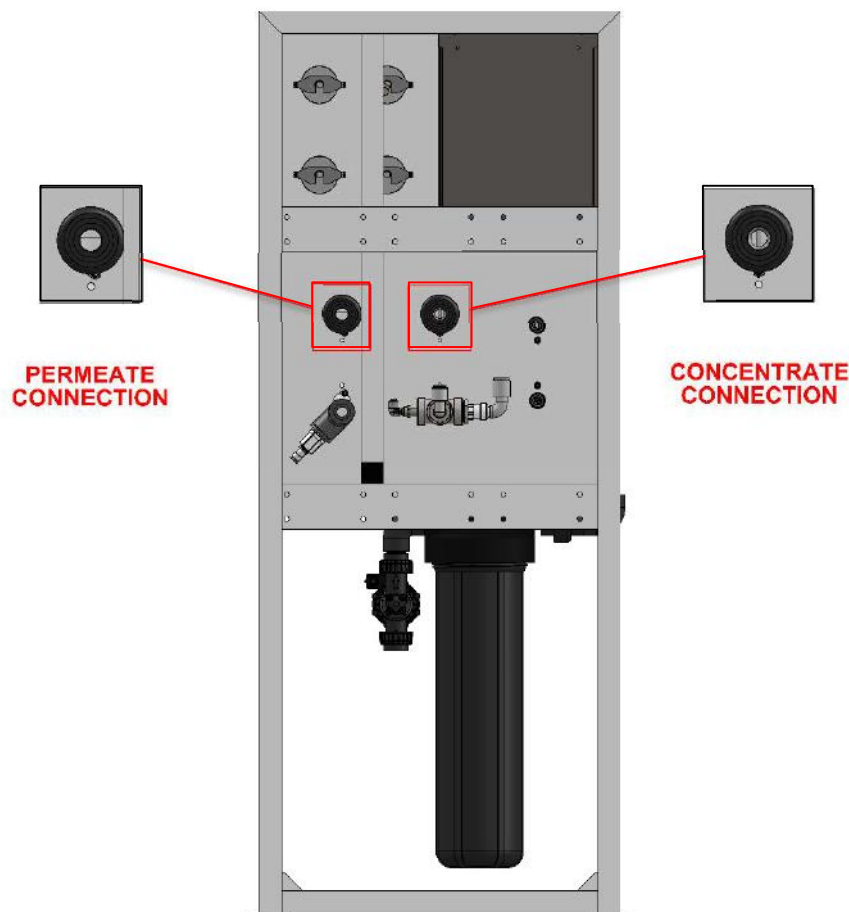



**ANY RESTRICTIONS OR BLOCKAGE IN THE DRAIN LINE CAN CAUSE BACKPRESSURE, WHICH WILL INCREASE THE SYSTEM'S OPERATING PRESSURE. THIS CAN RESULT IN DAMAGE TO THE SYSTEM'S MEMBRANES AND COMPONENTS.**

## **ELECTRICAL**

R1 – Series systems are available in the following configurations 220V/50-60HZ/1PH, 220V, 50-60HZ/3PH, 460V/60HZ/3PH, 380V/50HZ/3PH.

It is best that your R1 – Series system be wired to a dedicated electrical circuit. Ensure that the electrical circuit supplying the system is compatible with the requirements of the specific R1 – Series model you are installing.



**TO REDUCE THE RISK OF ELECTRICAL SHOCK, THE INCOMING POWER SUPPLY MUST INCLUDE A PROTECTIVE EARTH GROUND.**



**IT IS RECOMMENDED THAT A LICENSED ELECTRICIAN WIRE YOUR SYSTEM IN ACCORDANCE WITH LOCAL AND NATIONAL ELECTRICAL CODES (NEC).**

## **LIQUID LEVEL (FLOAT) SWITCH**

R1 – Series systems are typically controlled with a liquid level switch in a storage tank. The liquid level switch turns the system on when the water level in the tank drops, and off when the tank is full. Liquid level switches can be obtained by your local dealer or distributor. If a liquid level switch is to be used, install it at this time.

## MEMBRANE INFORMATION AND HANDLING



**ALL PRESSURE GAUGES MUST READ ZERO BEFORE BEGINNING THIS PROCEDURE. TURN THE SYSTEM OFF, DISCONNECT THE POWER, AND BLEED ALL WATER PRESSURE FROM THE SYSTEM**



**THE BRINE SEAL MUST BE IN THE CORRECT POSITION FOR EACH MEMBRANE HOUSING IN ORDER FOR THE MEMBRANE TO FUNCTION CORRECTLY.**

Pay close attention to the flow direction arrows on the membrane housings when installing new membranes. Refer to the following chart:

**R1 – 1140**



**R1 – 2140**

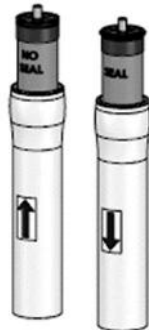

**R1 – 3140**



**R1 – 4140**



**R1 – 5140**



**R1 – 6140**



**R1 – 8140**



**R1 – 10140**



**R1 – 12140**



## MEMBRANE INSTALLATION/REPLACEMENT



**WEAR GLOVES FOR THE FOLLOWING STEPS IN ORDER NOT TO CONTAMINATE THE MEMBRANE.**

1. Remove the permeate plumbing and/or fittings from the permeate port of the top end plug on the pressure vessel. Unscrew and remove the two locking crescents using a #5 Hex wrench. It is strongly recommended that an end plug removal tool be used to remove end plugs (An end plug removal tool may available from the dealer or distributor through which you purchased the R1 – Series system). A 1/2" NPT male threaded PVC (or similar material) pipe can also be used if an end plug removal tool is not available. Thread the removal tool into the end plug permeate port to hand tightness. Pull the pipe outward to remove the end plug. If the pressure vessel has been in operation for an extended time, a slight rocking motion or forceful tug may be required. Set the end plug aside in a clean area where the O-ring will not pick up dirt or debris.

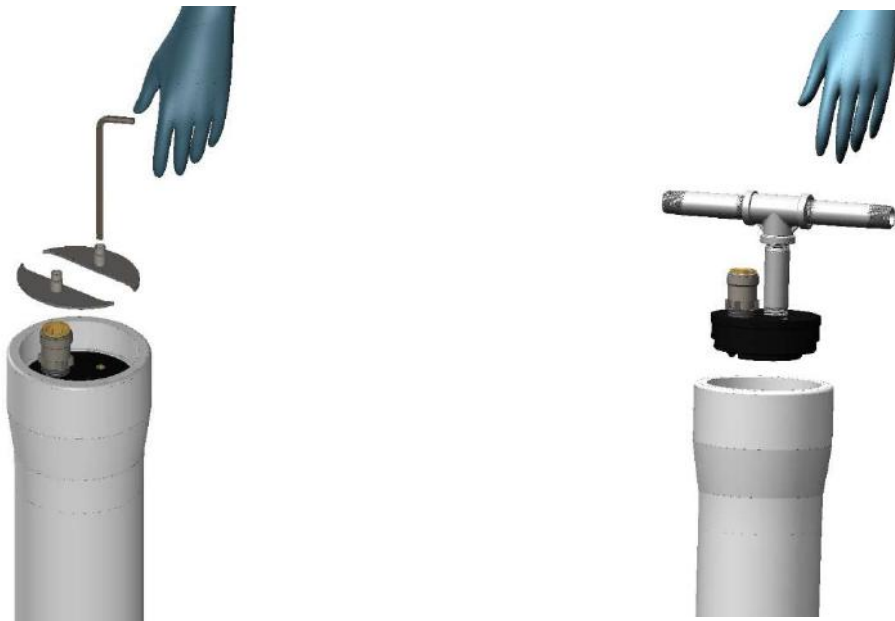

2. Remove the membrane bag containing the membrane element from the shipping box.
3. Cut the bag open as close as possible to the seal at the end of the bag, so the bag may be re-used if necessary.
4. Make sure that all parts are clean and free from dirt. Examine the brine seal and permeate tube for nicks or cuts. Replace the O-rings or brine seal if damaged.
5. Remove the old membranes from the pressure vessels. Long nose pliers may be necessary to pull the old membrane out of the pressure vessel.
6. Lubricate the brine seal and O-rings on the new membranes with a non-petroleum based lubricant, such as Dow Corning® 111. Do not use a petroleum-based lubricant.
7. Apply the same lubricant to the inside of the pressure vessel below the groove for the locking crescents, where the membrane brine seal will make contact when inserted.
8. Install membranes with brine seal location depicted in the membrane flow chart on the previous page.
9. When loading a membrane brine seal first, insert the membrane at a slight angle while gently rotating, being careful not to tear or flip the brine seal. With a smooth and constant motion, carefully push the membrane into the pressure vessel. A slow twisting motion

should be used while inserting the membrane to ensure the brine seal stays in place. If there is considerable resistance when attempting to insert the membrane, remove it and re-lube the brine seal and pressure vessel entrance as necessary. Pushing the membrane into the pressure vessel forcefully will cause the brine seal to flip at which point the membrane will no longer operate properly.

10. The membrane should stop when fully seated in the bottom end plug.
11. Reassemble the top end plugs.



**MAKE SURE THE O-RINGS AND END PLUGS ARE FREE FROM DIRT AND DEBRIS BEFORE RE-INSTALLING. DIRT AND OTHER FOREIGN MATERIALS LEFT ON THE END PLUGS CAN DAMAGE THE MEMBRANES AND CAUSE CONTAMINATION.**

12. Re-install the end plugs by gently and evenly pushing them onto the pressure vessel. Ensure that you do not pinch or fatigue any O-rings while re-installing the end plug. Push the end plug in until it is seated just below the groove for the locking crescents.
13. Reinstall the locking crescents and securely tighten the screws.
14. Reconnect any fittings that may have been disconnected when the pressure vessels were disassembled.
15. To start-up the system, please refer to the System Purging/Initial Start-Up section of this User's Manual.



**WET MEMBRANES ARE SHIPPED IN A PRESERVATIVE SOLUTION. THE MEMBRANES MUST BE FLUSHED FOR AT LEAST 1 HOUR TO REMOVE THE PRESERVATIVE FROM THE MEMBRANE. DISCARD ALL OF THE PERMEATE PRODUCED DURING THE FLUSH PERIOD.**



## SYSTEM PURGING / INITIAL START UP



**CAREFULLY INSPECT YOUR SYSTEM BEFORE INITIAL START UP. CHECK THAT ALL THE PLUMBING AND ELECTRICAL CONNECTIONS ARE IN PLACE AND SECURELY FASTENED.**

**LEAVE THE POWER TO THE SYSTEM OFF UNTIL STEP 8 OF THIS PROCEDURE.**

1. Redirect permeate water to the drain for this procedure.
2. Fully open the concentrate valve. (counter clockwise).

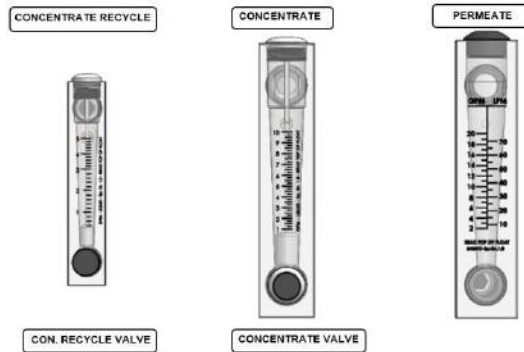

3. Fully close the recycle valve. (clockwise).
4. Activate the system purge feature by pressing and holding the red Alarm Silence/Reset button on the S – 150 Controller for 5 seconds. The inlet valve will open and the system will flush for 2 minutes.

Note: If the system is equipped with a Permeate Flush option, you will have to unlock the “WRITE PROTECT” next to “CPU ACTIVE” and remove the jumper from “ON” and reinsert it to the “OFF” position. Then go to “Flush Mode” on the controller and change the setting to “1” before purging the system. Once the system has

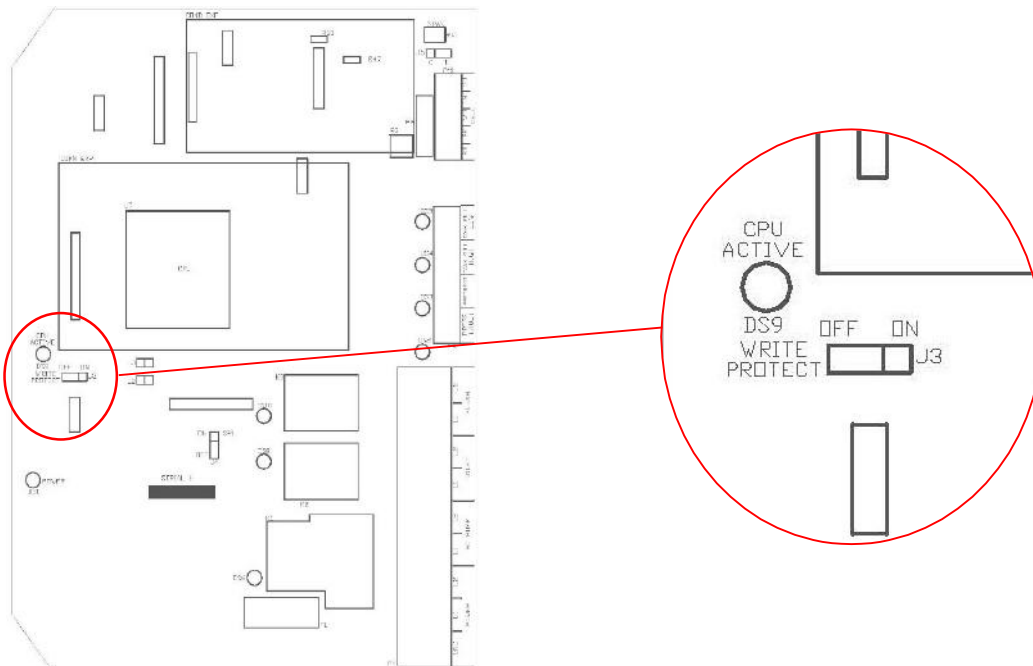

- been purged, go back to the “Flush Mode” and revert back the setting to “0”.
5. Let the system purge until no bubbles appear in concentrate flow meter. It may be necessary to flush the system more than one cycle.
  6. When the RO system has been purged of air, turn it on and slowly adjust the concentrate valve (and recycle valve if you are recycling water) to the designed flow and pressure. Close the small red lever on the top of the solenoid valve.
  7. Inspect the system for leaks.
  8. Allow the system to run uninterrupted for at least 1 hour to flush the preservative solution from the system.
  9. After 1 hour, shut down the system.
  10. Re-direct the permeate water back to the tank and then turn the system back on.
  11. Using the Reverse Osmosis System Operation Log provided on page 30, record your system’s readings daily for a week. After a week, record the readings at a minimum of once a week. It is suggested to make several copies of this sheet for future use before recording initial readings.



**IF THE SYSTEM HAS ANTISCALANTS OR ANTIFOULANTS INJECTED ALONG WITH A BLEND VALVE OPTION, AND IF THE PERMEATE WATER IS USED AS POTABLE WATER, THE SYSTEM MUST HAVE A POTABLE BLEND VALVE OPTION. THIS IS TO AVOID INJECTION OF ANY CHEMICALS. THE POTABLE/LOW PRESSURE WATER BLEND OPTION ISOLATES THE CHEMICALS FROM DIRECT INJECTION INTO THE PRODUCT WATER. CONTACT YOUR DEALER OR DISTRIBUTER FOR MORE INFORMATION.**

## FLUSHING THE SYSTEM

As time progresses, the efficiency of the membrane will be reduced. In general, the salt rejection does not change significantly until two or three years after installation when operated on properly pretreated feedwater. The permeate flow rate will begin to decline slightly after one year of operation, but can be extended with diligent flushing and cleaning of the membranes. The system should be flushed regularly to remove sediment from the surface of the membranes. R1 – Series systems are preprogrammed to flush for 2 minutes upon tank full shut down. Should your application require another configuration, the S – 150 controller provides several flush types, modes, and times to select from. Please refer to the controller section of this manual for easy to follow programming instructions.

## PREPARING UNIT FOR STORAGE

If the system is to be shut down for an extended period, a membrane preservative should be used to preserve the membranes.



**PRIOR TO STORING YOUR SYSTEM, THE SYSTEM SHOULD BE CLEANED WITH AN APPROPRIATE CLEANER, FLUSHED WITH PERMEATE WATER AND M – 100 SOLUTION FOR MEMBRANES TO PROTECT IT FROM BIOLOGICAL ATTACK.**



**THE PRESSURE VESSELS AND PLUMBING LINES OF THE SYSTEM MUST BE COMPLETELY DRAINED OR FILLED WITH GLYCOL (TO PREVENT FREEZING). ANY WATER REMAINING IN THE PLUMBING OF A SYSTEM MAY FREEZE, CAUSING SERIOUS DAMAGE.**

1. Completely immerse the elements in the membrane housings using 2% M – 100 solution\*.  
\*For cold weather/winter storage add 20 - 40% by weight Polyglycol to the 2% M – 100 solution. Add Polyglycol AFTER the 2% M – 100 solution has been mixed.
2. Separate the preservative solution from the air outside by closing all valves. Any contact with oxygen will oxidize the M – 100 solution.
3. Check the pH once a week. When the pH becomes 3 or lower, change the preservation solution.
4. Repeat this process at least once a month.

## TEMPERATURE CORRECTION FACTORS FOR MEMBRANES

A membrane's stated permeate production rate is based on a water temperature of 77 °F degrees Fahrenheit. Temperatures above or below 77 °F will increase or decrease the membrane's production rate.

Find the temperature correction factor (TCF) for your water temperature on the table located on the next page. Divide the rated permeate flow by the temperature correction factor. The result is the nominal permeate flow rate the system should achieve at actual water temperature. Permeate flow should be within 20% of the rated production, after correcting the feedwater temperatures above or below 77 °F. Check your permeate flow meter to determine the permeate flow rate.

Example:

$$5 \text{ GPM at } 59 \text{ }^{\circ}\text{F} \rightarrow \frac{5 \text{ GPM}}{1.42} = 3.52 \text{ GPM}$$

$$5 \text{ GPM at } 77 \text{ }^{\circ}\text{F} \rightarrow \frac{5 \text{ GPM}}{1} = 5 \text{ GPM}$$

$$5 \text{ GPM at } 84 \text{ }^{\circ}\text{F} \rightarrow \frac{5 \text{ GPM}}{.89} = 5.62 \text{ GPM}$$

# TEMPERATURE CORRECTION TABLE

Temperature °F (°C)	Temperature Correction Factor	Temperature °F (°C)	Temperature Correction Factor	Temperature °F (°C)	Temperature Correction Factor	Temperature °F (°C)	Temperature Correction Factor	Temperature °F (°C)	Temperature Correction Factor
50.0 (10.0)	1.711	57.2 (14.0)	1.475	64.4 (18.0)	1.276	71.6 (22.0)	1.109	78.8 (26.0)	0.971
50.2 (10.1)	1.705	57.4 (14.1)	1.469	64.6 (18.1)	1.272	71.8 (22.1)	1.105	79.0 (26.1)	0.968
50.4 (10.2)	1.698	57.6 (14.2)	1.464	64.8 (18.2)	1.267	72.0 (22.2)	1.101	79.2 (26.2)	0.965
50.5 (10.3)	1.692	57.7 (14.3)	1.459	64.9 (18.3)	1.262	72.1 (22.3)	1.097	79.3 (26.3)	0.962
50.7 (10.4)	1.686	57.9 (14.4)	1.453	65.1 (18.4)	1.258	72.3 (22.4)	1.093	79.5 (26.4)	0.959
50.9 (10.5)	1.679	58.1 (14.5)	1.448	65.3 (18.5)	1.254	72.5 (22.5)	1.090	79.7 (26.5)	0.957
51.1 (10.6)	1.673	58.3 (14.6)	1.443	65.5 (18.6)	1.249	72.7 (22.6)	1.086	79.9 (26.6)	0.954
51.3 (10.7)	1.667	58.5 (14.7)	1.437	65.7 (18.7)	1.245	72.9 (22.7)	1.082	80.1 (26.7)	0.951
51.4 (10.8)	1.660	58.6 (14.8)	1.432	65.8 (18.8)	1.240	73.0 (22.8)	1.078	80.2 (26.8)	0.948
51.6 (10.9)	1.654	58.8 (14.9)	1.427	66.0 (18.9)	1.236	73.2 (22.9)	1.075	80.4 (26.9)	0.945
51.8 (11.0)	1.648	59.0 (15.0)	1.422	66.2 (19.0)	1.232	73.4 (23.0)	1.071	80.6 (27.0)	0.943
52.0 (11.1)	1.642	59.2 (15.1)	1.417	66.4 (19.1)	1.227	73.6 (23.1)	1.067	80.8 (27.1)	0.940
52.2 (11.2)	1.636	59.4 (15.2)	1.411	66.6 (19.2)	1.223	73.8 (23.2)	1.064	81.0 (27.2)	0.937
52.3 (11.3)	1.630	59.5 (15.3)	1.406	66.7 (19.3)	1.219	73.9 (23.3)	1.060	81.1 (27.3)	0.934
52.5 (11.4)	1.624	59.7 (15.4)	1.401	66.9 (19.4)	1.214	74.1 (23.4)	1.056	81.3 (27.4)	0.932
52.7 (11.5)	1.618	59.9 (15.5)	1.396	67.1 (19.5)	1.210	74.3 (23.5)	1.053	81.5 (27.5)	0.929
52.9 (11.6)	1.611	60.1 (15.6)	1.391	67.3 (19.6)	1.206	74.5 (23.6)	1.049	81.7 (27.6)	0.926
53.1 (11.7)	1.605	60.3 (15.7)	1.386	67.5 (19.7)	1.201	74.7 (23.7)	1.045	81.9 (27.7)	0.924
53.2 (11.8)	1.600	60.4 (15.8)	1.381	67.6 (19.8)	1.197	74.8 (23.8)	1.042	82.0 (27.8)	0.921
53.4 (11.9)	1.594	60.6 (15.9)	1.376	67.8 (19.9)	1.193	75.0 (23.9)	1.038	82.2 (27.9)	0.918
53.6 (12.0)	1.588	60.8 (16.0)	1.371	68.0 (20.0)	1.189	75.2 (24.0)	1.035	82.4 (28.0)	0.915
53.8 (12.1)	1.582	61.0 (16.1)	1.366	68.2 (20.1)	1.185	75.4 (24.1)	1.031	82.6 (28.1)	0.913
54.0 (12.2)	1.576	61.2 (16.2)	1.361	68.4 (20.2)	1.180	75.6 (24.2)	1.028	82.8 (28.2)	0.910
54.1 (12.3)	1.570	61.3 (16.3)	1.356	68.5 (20.3)	1.176	75.7 (24.3)	1.024	82.9 (28.3)	0.908
54.3 (12.4)	1.564	61.5 (16.4)	1.351	68.7 (20.4)	1.172	75.9 (24.4)	1.021	83.1 (28.4)	0.905
54.5 (12.5)	1.558	61.7 (16.5)	1.347	68.9 (20.5)	1.168	76.1 (24.5)	1.017	83.3 (28.5)	0.902
54.7 (12.6)	1.553	61.9 (16.6)	1.342	69.1 (20.6)	1.164	76.3 (24.6)	1.014	83.5 (28.6)	0.900
54.9 (12.7)	1.547	62.1 (16.7)	1.337	69.3 (20.7)	1.160	76.5 (24.7)	1.010	83.7 (28.7)	0.897
55.0 (12.8)	1.541	62.2 (16.8)	1.332	69.4 (20.8)	1.156	76.6 (24.8)	1.007	83.8 (28.8)	0.894
55.2 (12.9)	1.536	62.4 (16.9)	1.327	69.6 (20.9)	1.152	76.8 (24.9)	1.003	84.0 (28.9)	0.892
55.4 (13.0)	1.530	62.6 (17.0)	1.323	69.8 (21.0)	1.148	77.0 (25.0)	1.000	84.2 (29.0)	0.889
55.6 (13.1)	1.524	62.8 (17.1)	1.318	70.0 (21.1)	1.144	77.2 (25.1)	0.997	84.4 (29.1)	0.887
55.8 (13.2)	1.519	63.0 (17.2)	1.313	70.2 (21.2)	1.140	77.4 (25.2)	0.994	84.6 (29.2)	0.884
55.9 (13.3)	1.513	63.1 (17.3)	1.308	70.3 (21.3)	1.136	77.5 (25.3)	0.991	84.7 (29.3)	0.882
56.1 (13.4)	1.508	63.3 (17.4)	1.304	70.5 (21.4)	1.132	77.7 (25.4)	0.988	84.9 (29.4)	0.879
56.3 (13.5)	1.502	63.5 (17.5)	1.299	70.7 (21.5)	1.128	77.9 (25.5)	0.985	85.1 (29.5)	0.877
56.5 (13.6)	1.496	63.7 (17.6)	1.294	70.9 (21.6)	1.124	78.1 (25.6)	0.982	85.3 (29.6)	0.874
56.7 (13.7)	1.491	63.9 (17.7)	1.290	71.1 (21.7)	1.120	78.3 (25.7)	0.979	85.5 (29.7)	0.871
56.8 (13.8)	1.486	64.0 (17.8)	1.285	71.2 (21.8)	1.116	78.4 (25.8)	0.977	85.6 (29.8)	0.869
57.0 (13.9)	1.480	64.2 (17.9)	1.281	71.4 (21.9)	1.112	78.6 (25.9)	0.974	85.8 (29.9)	0.866

# REVERSE OSMOSIS SYSTEM OPERATION LOG

- Company Name \_\_\_\_\_

- Day of Start Up \_\_\_\_\_

- Location \_\_\_\_\_

- Date of Last Cleaning \_\_\_\_\_

- Week Of \_\_\_\_\_

- System Serial No. \_\_\_\_\_

Date					
Time					
Hour of Operation					
Filter Inlet Pressure (PSI)					
Filter Outlet Pressure (PSI)					
Concentrate Pressure (PSI)					
Pump Discharge Pressure (PSI)					
Feed Flow (GPM)					
Permeate Flow (GPM)					
Concentrate Flow (GPM)					
Recycle Flow (GPM)					
Recovery %					
Feed Temperature					
Feed TDS (PPM)					
Permeate TDS (PPM)					
Rejection %					
Feed pH					
Permeate pH					
Scale Inhibitor Feed (PPM)					
Iron (mg/L)					
Free Chlorine (mg/L)					
Hardness (GPG CaCO <sub>3</sub> )					

## TROUBLESHOOTING CHART

SYMPTOMS	POSSIBLE CAUSES	CORRECTIVE ACTION
Low Inlet Pressure	Low supply pressure	Increase inlet pressure
	Cartridge filters plugged	Change filters
	Solenoid valve malfunction	Inspect / Replace sol. valve and/or coil
	Leaks	Fix any visible leaks
	Low inlet flow	Adjust concentrate valve
	Cold feedwater	See temperature correction sheet
Low Permeate Flow	Low operating pressure	See low inlet pressure
	Defective membrane brine seal	Inspect and/or replace brine seal
	Fouled or scaled membrane	Clean membranes
High permeate flow	Exceeding maximum feedwater temperature	See temperature correction sheet
	Damaged or oxidized membrane	Replace membrane
	Damage product tube O-rings	Inspect and/or replace
Poor permeate quality	Damaged or oxidized membrane	Replace membrane
	Metal Oxide Fouling	Improve pretreatment to remove metals. Clean with acid cleaners.
	Colloidal Fouling	Optimize pretreatment for colloid removal. Clean with high pH anionic cleaners.
Membrane fouling	Scaling (CaSO <sub>4</sub> , CaSO <sub>3</sub> , BaSO <sub>4</sub> , SiO <sub>2</sub> )	Increase acid addition and antiscalant dosage for CaCO <sub>3</sub> and CaCO <sub>4</sub> . Reduce recovery. Clean with acid cleaners
	Biological Fouling	Shock dosage of Sodium Bi-Sulfate. Continuous feed of Sodium Bi-Sulfate at reduced pH. Chlorination and de-chlorination. Replace cartridge filters.
	Organic Fouling	Activated Carbon or other pretreatment. Clean with high pH cleaner.
	Chlorine Oxidation	Check chlorine feed equipment and de-chlorination system.
	Abrasion of membrane by Crystalline Material	Improve pretreatment. Check all filters for media leakage.

## TECHNICAL ASSISTANCE

If technical assistance is required:

- Contact your local dealer or distributor
- Prior to making the call, have the following information available:
  - System installation date
  - Serial number
  - Daily log sheets
  - Current operating parameters (e.g., flow, operating pressures, pH, etc.)
  - Detailed description of the problem



### CONTROLLER SPECIFICATIONS

Power:	85 – 265VAC 50/60Hz, 25Watts
Environment:	–22°F to 140°F, 0 – 95% RH, noncondensing
Enclosure:	NEMA 4X
Display:	2 line x 20 character, alphanumeric backlit LCD
Front Panel:	Overlay with LCD window, alarm lamp, 7 key membrane switch Switch Inputs, Dry Contact: <ul style="list-style-type: none"><li>• Pressure fault</li><li>• Pretreat lockout</li><li>• Tank full high</li><li>• Tank full low</li></ul>
Relay Outputs:	RO pump relay 120/240VAC, 1HP Inlet valve relay 120/240VAC, 5A Flush valve relay 120/240VAC, 5A
Cell:	TDS / Conductivity cell with digital display, permeate standard range, 0 – 250 PPM or $\mu$ S.
Other ranges available:	Permeate: 50; 100; 500; 1,000; 2,500; 5,000.
Optional Feed:	50; 100; 500; 1,000; 2,500; 5,000; 10,000. Wetted parts ABS and 316SS, 3/4" NPT, maximum 300 psi
Optional I/O expander:	Auxiliary/divert/boost relay 120/240VAC, 1HP Divert/alarm relay 120/240VAC, 5A Tank low switch input, dry contact



## FRONT PANEL CONTROLS AND INDICATORS

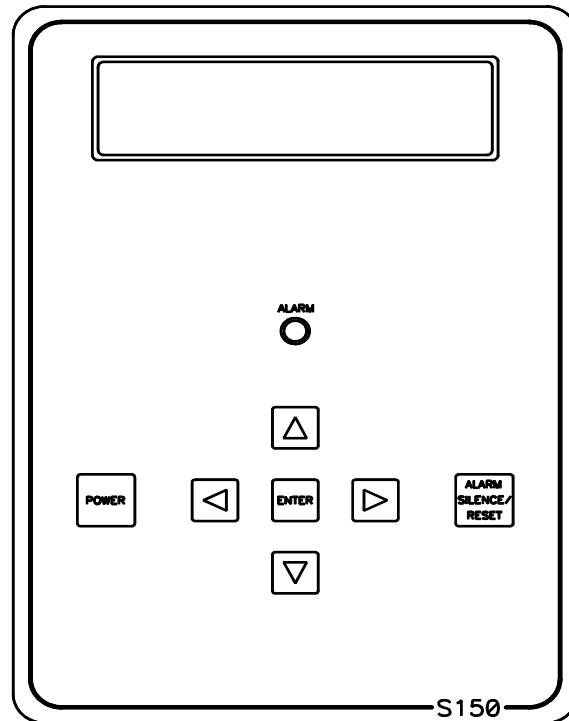

Figure. 1

DISPLAY:	Shows status of system.
ALARM LAMP:	Flashes when fault causes the RO system to shut down. On steady when a Setpoint is exceeded that does not cause the RO system to shut down.
POWER KEY:	Places controller in operating or standby mode.
LEFT ARROW KEY:	Scrolls through Setpoints starting with first Setpoint.
RIGHT ARROW KEY:	Scrolls through Setpoints starting with last Setpoint.
UP ARROW KEY:	Increases value of Setpoint.
DOWN ARROW KEY:	Decreases value of Setpoint
ENTER KEY:	Confirms entry of new Setpoint value.
ALARM SILENCE/RESET KEY:	Push once for alarm silence and twice to reset system after a shutdown has occurred.

## INSTALLATION

### PHYSICAL INSTALLATION

Mount the S – 150 Series controller in a convenient location on the RO equipment using the four mounting ears provided with the unit or the optional panel mounting bracket.

NOTE: All terminals on the board are labeled.

### TERMINAL STRIP, JUMPER AND ADJUSTMENT LOCATIONS

Refer to Figure 2 for the location of all terminal strips and connectors. Figure 2 also shows all jumper and adjustment locations. Figure 3 shows a sample wiring diagram.

### POWER WIRING

Refer to Figure 2 and Figure 3 for the terminal strip locations. AC power for the unit is connected to terminal strip P1. Connect the ground wire of the AC power to the terminal labeled GND. For AC power with a neutral and hot wire, the hot wire connects to L1 and the neutral wire connects to L2. For AC power with two hot wires, either wire can connect to L1 and L2. On AC power with two hot wires, the wire jumper between P6 and P7 should be removed and a fuse (GMA 1/4A) installed in F2.

### PUMP AND VALVE RELAY OUTPUTS

The S – 150 Series controller supplies relay outputs to control the RO pump and solenoid valves.

NOTE: The relays output the same voltage as the AC power to the board. If the pump and solenoids operate on different voltages, a contactor will need to be supplied to operate the pump.

### RO PUMP WIRING

The RO pump connects to the L1 and L2 RO pump terminals of P1. This output can operate 120/240VAC motors up to 1HP directly. For motors larger than 1HP or 3 phase motors, this output can be used to operate a contactor.

### INLET AND FLUSH VALVE WIRING

The inlet and flush valves must operate at the same voltage as supplied to the board. These outputs can supply 5A maximum and are not designed to operate pump motors directly. If these outputs are to be used to operate a boost or flush pump, the output should be used to operate a contactor. The inlet valve connects to the L1 and L2 inlet terminals of P1. The flush valve connects to the L1 and L2 flush terminals of P1.

### TDS / CONDUCTIVITY CELL WIRING

For accurate TDS / Conductivity readings, the cell should be installed in a tee fitting where a continuous flow of water passes over the cell and no air can be trapped around the cell. Refer to Figure 5 for example installation. The cell is connected with five wires to terminal strip P10. Connect each colored wire to the terminal labeled with the same color.

## SWITCH INPUTS

Switch inputs are connected to P9. The connections for these inputs are not polarity sensitive and can be connected to either terminal. The switch inputs should be dry contact closures only.

NOTE: Applying voltage to these terminals will damage the controller. The switches can be either normally open or normally closed in any combination. The switch connected to an input that is configured as normally open must be open for the unit to run. The switch connected to an input that is configured as normally closed must be closed for the unit to run. The Switch Select Setpoint allows each input to be configured as normally open or normally closed. The Switch Select Setpoint is defaulted to zero, which programs all inputs as normally open. This means that all switch inputs must be open for the unit to run. Table 1 lists the values used to program the Setpoint to configure the inputs.

TABLE 1. Switch Select Programming

SWITCH	N.O.	N.C.	PRESET VALUES
PRESSURE FAULT	0	1	1
PRETREAT	0	2	2
TANK FULL HIGH	0	4	4
TANK FULL LOW	0	8	
TANK LOW	0	16	
		TOTAL	7

Select the type of switch used for each input and put that number in the value column. Add the values and program the total in the Switch Select Setpoint. For example, if the pressure fault and tank low inputs were normally closed and all others normally open, the value programmed in the Switch Select Setpoint would be 17(1 + 16).

### PRESSURE FAULT SWITCH

On systems where a low feed pressure shutdown is required, a feed pressure switch can be connected to the pressure fault input of P9. If a high pump pressure shutdown is required, a high pressure switch can be connected to this input. If both low feed pressure and high pump pressure shutdown are required, both switches can be connected to this input. Both switches must be either normally open or normally closed to operate properly.

### PRETREAT SWITCH

In systems with pretreatment, a pretreat lockout switch can be connected to the pretreat input of P9. This switch should operate when the pretreatment device is out of service.

NOTE: The output from the pretreatment device must be a dry contact and must not supply voltage.

### TANK FULL SWITCH

In systems with a single tank level switch for controlling the RO pump, the level switch connects to the tank full high input of P9. If dual level switches are used for controlling the RO pump, the upper level switch connects to the tank full high input of P9 and the lower level switch connects to the tank full low input of P9.

## I/O EXPANDER BOARD

If the optional I/O expander board is installed, two additional relay outputs and one additional switch input are provided. Refer to Figure 4 for the location of terminal strips, jumpers and wiring for this board. AC power for the relays is connected to the L1 and L2 power terminals of P1. Relay 1 is connected to this power input and will supply the same voltage. This relay is rated for 120/240VAC at 1HP maximum. Relay 1 can be configured to supply a dry contact by connecting a jumper wire between the L1 and L2 power terminals of P1.

NOTE: If Relay 1 is configured as a dry contact, Relay 2 must be configured as a dry contact also. If Relay 1 is configured to supply voltage, Relay 2 can be selected to supply voltage, 120/240, 5A maximum, or as a dry contact output. Jumpers J1–J4 are used to select the Relay 2 output type. To output voltage, a wire jumper is installed between J1 and J4 and a second wire jumper is installed between J2 and J3. For a contact closure output, a single wire jumper is installed between J3 and J4. Relay 2 outputs can be selected to operate as an auxiliary pump output, a divert output or an alarm output by programming the Expander Mode Setpoint. Table 2 shows the values used to program the relay outputs.

TABLE 2. Expander Mode Programming

EXPANDER MODE	RELAY 1	RELAY 2
0	AUXILIARY PUMP	DIVERT
1	AUXILIARY PUMP	ALARM
2	DIVERT	ALARM
3	BOOST	DIVERT
4	BOOST	ALARM

### AUXILIARY PUMP

If the Expander Mode Setpoint is programmed to zero or one, Relay 1 operates as an auxiliary pump output. This output is energized when the tank low input is not active. This output will supply power or a contact closure determined by the connections L1 and L2 of the terminal strip P1.

### BOOST PUMP

If the Expander Mode Setpoint is programmed to three or four, Relay 1 operates as a boost pump output. This output is energized when the inlet solenoid output is active. This output will supply power or a contact closure determined by the connections L1 and L2 of the terminal strip P1.

### DIVERT OUTPUT

If the Expander Mode Setpoint is programmed to zero or three, Relay 2 operates as a divert relay and will operate whenever the unit is in the divert mode. This output will supply voltage or provide a contact closure based on the configuration of Relay 1 and on the position of jumpers J1–J4. If the Expander Mode Setpoint is programmed to two, Relay 1 operates as a divert relay and will operate whenever the unit is in the divert mode. This output will supply power or a contact closure determined by the connections L1 and L2 of the terminal strip P1.

### ALARM OUTPUT

If the Expander Mode Setpoint is programmed to one, two or four, Relay 2 operates as an alarm relay. When an alarm or warning is active, this relay will supply voltage or provide a contact closure based on the configuration of Relay 1 and the position of jumpers J1 – J4.

## TANK LOW SWITCH

A tank low switch input can be connected to the tank low input of P2 on the expander board. This input will provide a tank low warning on the unit and if the expander is programmed to provide an auxiliary pump output, will provide low tank level protection for this pump.

# TERMINAL STRIP, JUMPER LOCATIONS

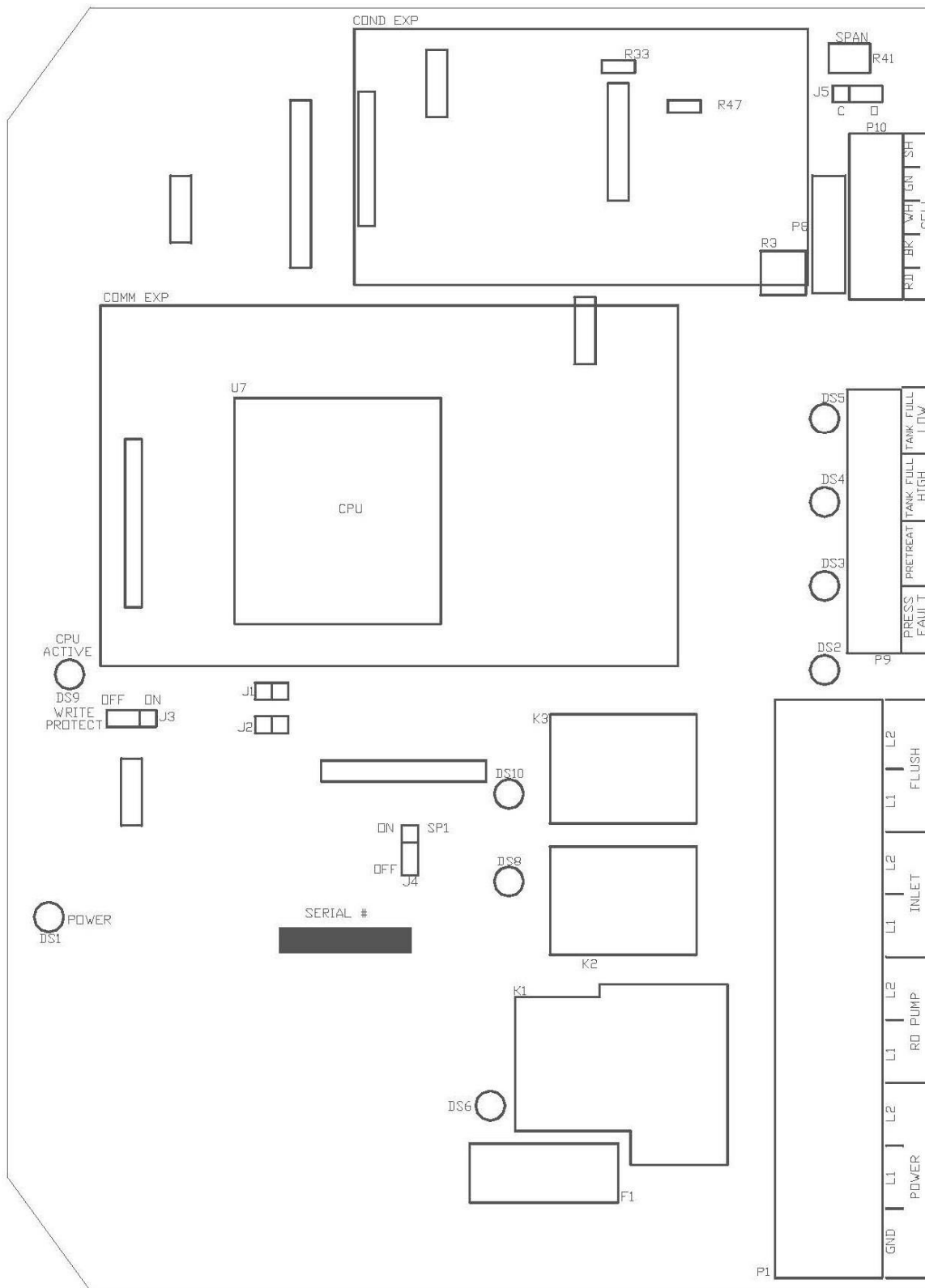

Figure 2

# SAMPLE WIRING

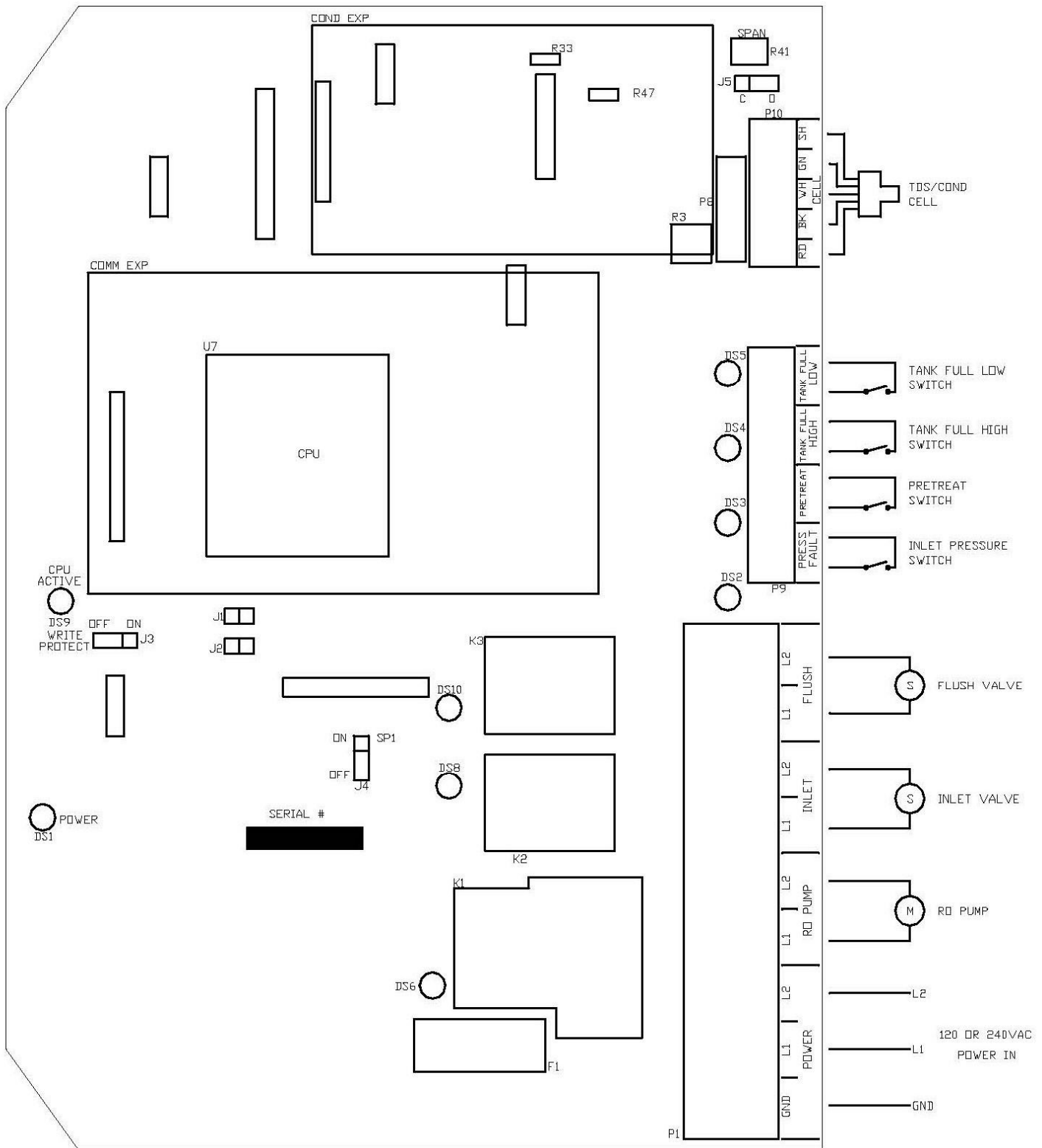

Figure 3

## EXPANDER BOARD TERMINAL STRIP, JUMPER LOCATIONS

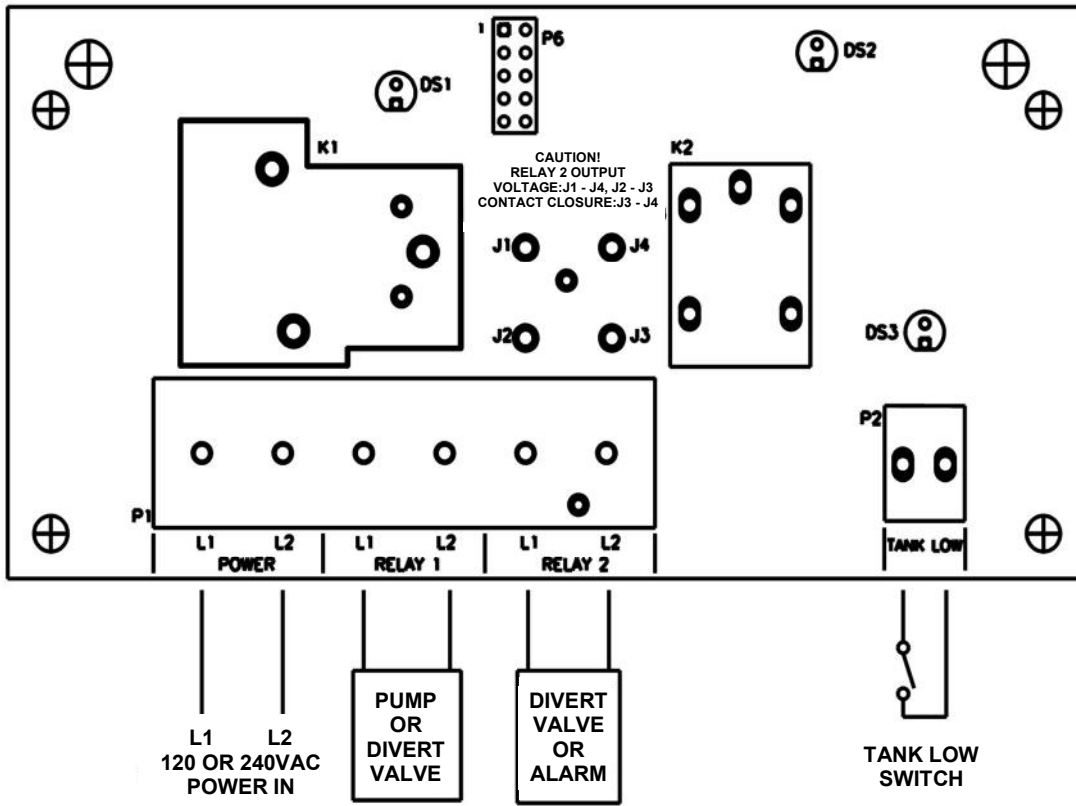

Figure 4

## TDS / CONDUCTIVITY CELL INSTALLATION

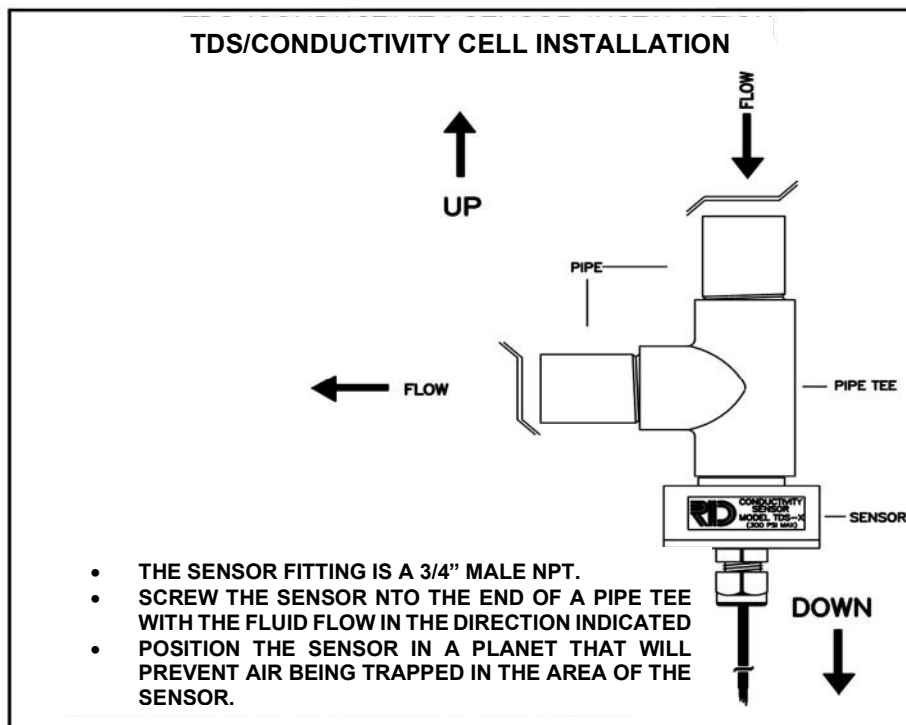

Figure 5



STANDARD SETPOINTS			
SETPOINT	DESCRIPTION	RANGE	DEFAULT
TDS / Conductivity Limit	When this value is met or exceeded, the alarm lamp will light and high TDS / Conductivity will show on the display. To disable, set to zero.	0 – 999 $\mu$ S or ppm	100
TDS / Conductivity Delay	When the limit Setpoint is exceeded, no alarm will be given until this time has expired.	0 – 999 seconds	30
TDS / Conductivity Shutdown	Once a TDS / Conductivity alarm is active, if the time in this exceeded, a TDS / Conductivity shutdown will occur. To disable, set to zero.	0 – 99 minutes	0
RO Start Delay	The amount of time between the inlet valve opening and the RO pump start.	0 – 99 seconds	5
Press Fault Delay	The time a pressure fault must be active before a pressure fault shutdown occurs.	0 – 99 seconds	5
Auto Reset	When a pressure fault shutdown is active, the system will attempt to restart after this delay. If set to zero, system must be manually reset.	0 – 99 minutes	5
Alarm Silence	If the audible alarm is silenced after this delay, the alarm will resound. If set to zero minutes the alarm will remain silenced.	0 – 99 minutes	0
TF Restart Delay	When a tank full condition clears, the system will restart after this delay.	0 – 99 seconds/minute	5
TF Restart	Selects whether the tank full restart delay is in seconds or minutes. 0 = seconds, 1 = minutes.	0 – 1	0
TFO Time	The amount of time that a tank full override lasts.	0 – 9 minutes	5
Tank Lo Restart	When a tank low condition clears, the auxiliary pump will restart after this delay.	0 – 99 minutes	15
Flush Type	Selects the type of flush. Set to zero to disable flush.	0 – 8	1
Flush Time	The length of time a membrane flush cycle will last when flush is active.	0 – 99 minutes	2
Flush Interval	The interval between flush cycles. Only valid with op hour, elapsed time or off flush types.	0 – 99 hours	24
Flush Mode	Selects if the inlet and RO pump relays operate during flush.	0 – 3	1
Maximum Hours	If the current operating hours exceed this limit, the operating hours warning will occur. To disable, set to zero.	0 – 65000 hours	0
Current Hours	Current number of hours of RO system operation.	0 – 65000	0
Expander Mode	Selects how the relays on the I/O expander board operate.	0 – 4	0
Temp Offset	Allows adjustment of temperature reading by $\pm$ 5 degrees.	-5 – +5	0
Temp UOM	Selects display of temperature in $^{\circ}$ F or $^{\circ}$ C.	0 – 1	0
Switch Select	Selects if switch inputs are normally open or normally closed.	0 – 32	7
TDS / Conductivity UOM	Selects display of water quality in $\mu$ S or PPM. NOTE: If this Setpoint is changed, the unit must be recalibrated.	0 – 1	0
TDS / Conductivity Range	Selects range of TDS / Conductivity monitor 0–50, 1–100, 2–250, 3–500, 4–1000, 5–2500, 6–5000 NOTE: If this Setpoint is changed, the unit must be recalibrated and may require some components be changed.	0 – 6	2
TF Delay	Selects delay time for Tank Full	0 – 5 seconds	5

## TO DISPLAY OR CHANGE SETPOINTS

1. Refer to Figure 1 for the location of the keys used to display or change the Setpoints and Figure 2 for the location of the write protect jumper, J3. For the unit to be able to accept a change in a Setpoint, the shorting jumper must be in the off position (center and left pins).  
NOTE: Setpoints cannot be changed if the write protect jumper is in the ON position.
2. Use the Left and Right arrow keys to display the Setpoints. Each press of an arrow key will advance the display to the next Setpoint. The Left arrow key starts with the beginning Setpoint and the Right arrow key starts with the last Setpoint.
3. The Up and Down arrow keys are used to increment or decrement the Setpoint value. The value will change by one count each time a key is pressed. If the key is pressed and held for less than one second, the Setpoint value will change at a fast rate. When the key is released, the fast rate will be reset. Pressing both the Up and Down arrow keys together will reset the Setpoint value to zero.
4. Pressing the Alarm Silence / Reset key at any time will cancel the operation and return the display to the main screen.
5. To accept the new Setpoint value, press the Enter key.
6. The unit will beep twice if the change is accepted. If the write protect jumper is on, the unit will show "WRITE PROTECTED" on the display and one long beep will sound.
7. When finished changing Setpoints, the write protect jumper should be placed in the on position (center and right pins).

## SYSTEM OPERATION

### GENERAL OPERATION

The unit has two modes of operation, a standby mode and an operating mode. In the standby mode, the unit is effectively off. All outputs are turned off and the display shows STANDBY. In the operating mode, the unit operates automatically. All inputs are monitored and the outputs are controlled accordingly. Pressing the Power key will toggle the unit from standby to operate, or from operate to standby. If power is removed from the unit, when power is reapplied, the unit will restart in the mode it was in when power was removed.

### DISPLAY

The display is a 2 line x 20-character backlit liquid crystal display. System operating status and sensor readings are shown on this display. Setpoint information is also shown on this display.

### OPERATING STATUS MESSAGES

The operating status of the unit is shown on the top line of the display. The following list describes the items shown for the operating status.

- |            |   |
|------------|---|
| STANDBY:   | The unit is in the standby mode.  |
| DELAY 99:  | The unit is in the RO start delay. The number is the seconds remaining before the RO pump starts. |
| OPERATING: | The RO unit is operating.   |

- TANK FULL: The unit is shut down due to a tank full condition.
- TANK FULL 99: The unit is shut down due to a tank full condition. If the number is blinking, the tank full high switch has cleared, but the tank full low switch is still active. If the number is on steady, both tank level switches have cleared and the delay is counting down.
- PRETREAT: The unit is shut down due to a pretreat lockout condition.
- PRESS FAULT: The unit is shut down due to a pressure fault condition.
- MEMB FLUSH 99: Membrane flush is active. The number is the minutes remaining in the flush cycle

### TDS / CONDUCTIVITY

The TDS / Conductivity is shown on the top line after the unit operating status. When the unit is offline because of a shutdown condition, the reading is replaced with '——'. If the reading is over range, the reading is shown as '^^^'.

### OPERATING HOURS

The current operating hours are shown on the bottom line.

### TEMPERATURE

The current water temperature is shown on the bottom line after the operating hours. When the unit is offline because of a shutdown condition, the reading is replaced with '——'.

### WARNING MESSAGES

Warning messages are also shown on the second line. If any warnings are active, the active warnings will alternate with the normal displays for the bottom line. The following lists the warning messages

- HI TDS / Conductivity: The TDS / Conductivity reading has exceeded the programmed limit.
- TANK LOW: The tank low input is active.
- TANK LOW 99: The tank low input has cleared, but the tank low restart delay is active.
- OP HOURS EXCEEDED: The current operating hours have exceeded the programmed limit.

### TANK FULL OPERATION

The unit can be operated with 1 or 2 level switches. With 1 level switch, the switch is connected to the tank full high input. When this switch has been active for five seconds, the unit will shut down on tank full. TANK FULL will show on the display. When the tank full condition clears, the display will show TANK FULL 99. The number is the tank full restart time and the unit will restart when this delay times out.

For 2 level switch operation, the upper switch is connected to the tank full high input and the lower switch is connected to the tank full low input. When both switches are clear, the RO unit will run. The RO unit will continue to run when the water level rises and the lower switch becomes active. When the upper switch becomes active, after the five second delay, the RO unit will shut down. TANK FULL will show on the display. When the tank level drops and the upper level switch clears, the display will show TANK FULL 99 and the RO unit will remain off. The number is the tank full restart time and the number will blink until the lower level switch clears. When the lower level switch clears, the number will remain steady and the RO will restart when the delay times out.

### TANK FULL RESTART

The tank full restart is the delay before the RO unit starts when a tank full condition clears. This delay can be in minutes or in seconds. The TF Restart Setpoint selects seconds or minutes.

### TANK FULL OVERRIDE

A timed tank full override can be initiated when the RO unit is shut down due to a tank full condition. Pressing the Alarm Silence/Reset key for three seconds during a tank full condition will enable the tank full override. The RO will start and TF OVERRIDE 9 will show on the display. The number is the minutes remaining in the override timer. When the override times out, the unit will return to the tank full shutdown condition.

### PRESSURE FAULT

If the pressure fault input becomes active and stays active for the delay programmed in the PF Delay Setpoint, the unit will shut down for a pressure fault. The display will show PRESS FAULT, the alarm lamp will flash and the audible alarm will sound. The pressure fault can be cleared by pressing the Alarm Silence/Reset key twice.

### AUTO RESET

If a pressure fault shutdown occurs and the Auto Reset Setpoint is programmed to zero, the unit will remain shut down until manually reset. If the Auto Reset Setpoint is programmed to a value greater than zero, the unit will automatically clear the pressure fault and attempt to restart after this delay times out.

### ALARM SILENCE

When a shutdown occurs that causes the audible alarm to sound, the alarm can be silenced by pressing the Alarm Silence/Reset key once. The alarm will remain silenced if the Alarm Silence Setpoint is programmed to zero. If the Alarm Silence Setpoint is programmed to a value greater than zero, the alarm will resound after this delay times out. Pressing the Alarm Silence/Reset key will silence the alarm and reset this delay.

### PRETREAT

If the pretreat input becomes active and stays active for two seconds, the unit will shut down in a pretreat lockout condition. PRETREAT will show on the display and the unit will remain shut down as long as the pretreat input is active.

## MEMBRANE FLUSH

If the Flush Type Setpoint is programmed to zero, flush is disabled. If membrane flush is desired, several types of flush are available. When the unit enters a flush cycle, the flush relay will activate. The flush cycle will last for the time programmed in the Flush Time Setpoint. Table 3 shows the value that must be programmed in the Flush Type Setpoint for each type of flush.

TABLE 3. Flush Type

FLUSH TYPE	DESCRIPTION
0	NO FLUSH
1	TANK FULL
2	OPERATING HOURS
3	OPERATING HOURS AND TANK FULL
4	ELAPSED TIME
5	ELAPSED TIME AND TANK FULL
6	OFF HOURS
7	OFF HOURS AND TANK FULL
8	RO START/STOP

**TANK FULL:** The RO unit will flush each time a tank full condition occurs.

**OPERATING HOURS:** A flush will occur when the RO pump has operated for the number of hours programmed in the Flush Interval Setpoint.

**ELAPSED TIME:** A flush will occur after the number of hours programmed in the Flush Interval Setpoint has passed.

**OFF HOURS:** A flush will occur when the RO has been shut down due to a tank full condition for the number of hours programmed in the Flush Interval Setpoint.

**RO START/STOP:** A flush will occur each time the RO starts or stops. The tank full flush can be combined with any of the three interval flush types. A manual flush can be initiated by pressing the Alarm Silence/Reset key for three seconds.

## FLUSH MODE

The Flush Mode Setpoint can be used to control the operation of the inlet valve and RO pump during flush. Each can be independently programmed to operate during flush. Table 4 shows the values to program into the Flush Mode Setpoint to control the operation of the inlet and RO outputs during flush.

TABLE 4. Flush Mode

FLUSH MODE	RO PUMP	INLET VALVE
0	OFF	CLOSED
1	OFF	OPEN
2	ON	CLOSED
3	ON	OPEN

## HIGH TDS / CONDUCTIVITY WARNING / ALARM

If the TDS / Conductivity reading exceeds the limit programmed the TDS / Conductivity Limit Setpoint for the delay programmed in the TDS / Conductivity Delay Setpoint, the alarm lamp will light and the HI TDS / Conductivity warning message will show on the display. This warning will clear when the TDS / Conductivity drops below the Setpoint. If the TDS / Conductivity Shutdown Setpoint is programmed to zero, the unit will continue to operate. Otherwise, once a high TDS / Conductivity warning occurs, after the time programmed in this Setpoint, the RO unit will shut down and the alarm will sound. The alarm can be cleared by pressing the Alarm Silence/Reset key twice.

NOTE: The auto reset function is not active for this shut down.

## OPERATING HOURS EXCEEDED

If the current hours exceed the limit programmed in the Maximum Hours Setpoint, the alarm lamp will light and the OP HOURS EXCEEDED warning message will be shown. This warning can be cleared by programming the current hours to zero or by increasing the maximum hours limit.

## I/O EXPANDER

The I/O Expander board adds 2 relays and 1 switch input. The operation and programming of the 2 relays is described in the installation section.

## AUXILIARY OUTPUT

Relay 1 can be used to control a repressurization pump when Relay 1 of the expander board is configured to operate an aux relay. In this mode, this relay will be energized as long as the tank low input is not active. When energized, the relay supplies power to the repressurization pump.

## TANK LOW

When the tank low input has been active for five seconds, the auxiliary output will turn off. The alarm lamp will light and the TANK LOW warning message will show on the display. When the tank low condition clears, the TANK LOW 99 warning message is displayed. The number is the delay in minutes before the auxiliary relay will energize.

For boost pump operation, when the tank low input has been active for five seconds, the boost pump output will turn off, the RO unit will shut down, the alarm lamp will flash and the audible alarm will sound. TANK LOW shutdown message will show on the display. When the tank low condition clears, the TANK LOW 99 shutdown message is displayed. The number is the delay before the RO unit will restart. The shutdown can be manually reset by pressing the Alarm Silence/Reset button twice.

## BOOST PUMP OUTPUT

Relay 1 can be used to control a boost pump when the expander board is configured to operate Relay 1 as a boost pump relay. This relay will operate the same as the inlet solenoid relay. This option is used to directly operate a boost pump up to 1HP.

## DIVERT OUTPUT

When Relay 1 or Relay 2 has been programmed to operate as a divert relay, the relay will energize when the TDS / Conductivity exceeds the TDS / Conductivity Limit Setpoint. This will occur as soon as the reading exceeds the limit, there is no delay. When the reading drops below the limit and stays below the limit continuously for five seconds, the divert relay will turn off.

## ALARM OUTPUT

When Relay 2 has been programmed to operate as an alarm relay, the relay will energize whenever a warning or alarm condition occurs. The relay will remain energized as long as the warning / alarm condition is active.

## ADJUSTMENTS

### TDS / CONDUCTIVITY CALIBRATION

Refer to Figure 2 for adjustment location. To calibrate the TDS / Conductivity, place the cell in a known standard solution. Adjust the span adjustment for the correct reading. If the cell is installed, the unit can be calibrated by taking a sample of the permeate water and testing it with a known, good meter. Adjust the span control until the reading matches the meter.

NOTE: If the TDS / Conductivity range is changed, the unit must be recalibrated and some components may need to be changed.

### DISPLAY ADJUSTMENT

The display contrast can be adjusted for best viewing by adjusting control R3. This control is located toward the upper right corner of the board, just to the left of the cell connector.

## TROUBLESHOOTING



**HAZARDOUS VOLTAGES ARE PRESENT WHEN POWER IS APPLIED TO THE UNIT. CARE SHOULD BE TAKEN WHEN TROUBLESHOOTING ANY OF THE INPUT POWER OR OUTPUT CIRCUITS. WHEN DISCONNECTING OR CONNECTING ANY BOARD OR ACCESSORY, BE SURE POWER IS TURNED OFF AT THE DISCONNECT.**

Verify the programming of all Setpoints, Check the display and check the status of all lights and indicators. The more information available, the easier it will be to determine the source of the problem.

### SYSTEM INOPERATIVE

Is the yellow CPU active LED blinking? If no, is the green power LED, DS1 Lit? If no, is the fuse OK? If no, replace the fuse. If yes, with a voltmeter, verify power is applied to the power terminals L1 and L2. If power is applied to the power terminals and the above checks are OK, the board is probably defective and should be replaced. If no power is applied to the board, check the power wiring to the system.

## DISPLAY BLANK

Is the green power LED, DS1 lit? If no, refer to the system inoperative section. If yes, is the CPU active LED, DS9 blinking? If no, replace the board. If yes, adjust the display contrast adjustment, R3. Is the display still blank? If yes, replace the board.

## INLET VALVE WILL NOT OPERATE

Is the system in standby? If no, are any shutdown conditions active? If no, is the inlet LED, DS8 lit? If no, replace the board. If yes, with a voltmeter, verify if there is power on the inlet terminals. Is there power? If no, replace the board. If yes, check the valve and wiring.

## RO PUMP WILL NOT OPERATE

Is the system in standby? If no, are any shutdown conditions active? If no, is the RO LED, DS6 lit?

If no, replace the board. If yes, with a voltmeter, verify if there is power on the RO pump terminals. Is there power? If no, replace the board. If yes, check the pump and wiring.

## UNIT NOT FLUSHING OR NOT FLUSHING CORRECTLY

Verify that flush is enabled and what type of flush is selected. Is flush enabled? If no, enable flush. If yes, press the Alarm Silence /Reset key for 3 seconds. Does the unit show flush on the display? If no, replace the board. If yes, is the flush LED, DS10 lit. If no, replace the board. If yes, with a voltmeter, verify if there is power on the flush terminals. Is there power? If no, replace the board. If yes, check the valve and wiring.

## NO OR INCORRECT TDS / CONDUCTIVITY READING

Is sensor wired correctly? If no, correct wiring. If yes, is sensor installed as described in the installation section? If no, install correctly. If yes, verify correct TDS / Conductivity range. Range correct? If no, correct range. If yes, calibrate unit. Does unit calibrate OK? If no, disconnect green and white wires of sensor. Does reading show 0? If no, replace board. If yes, reconnect wires and remove sensor from piping and dry. Does reading show 0? If no, replace cell. If yes, short pins of cell together. Does reading show '^^^'? If no, replace board.

## TDS / CONDUCTIVITY EXPANDER

### INSTALLATION / WIRING

The TDS / Conductivity expander board allows a 2<sup>nd</sup> TDS / Conductivity to be monitored and displayed by the S – 150 Series controller. The expander board is mounted on the main board to the left of the connector for the first cell. Figure 6 shows the wiring and adjustment information for the expander.



## TDS / CONDUCTIVITY EXPANDER

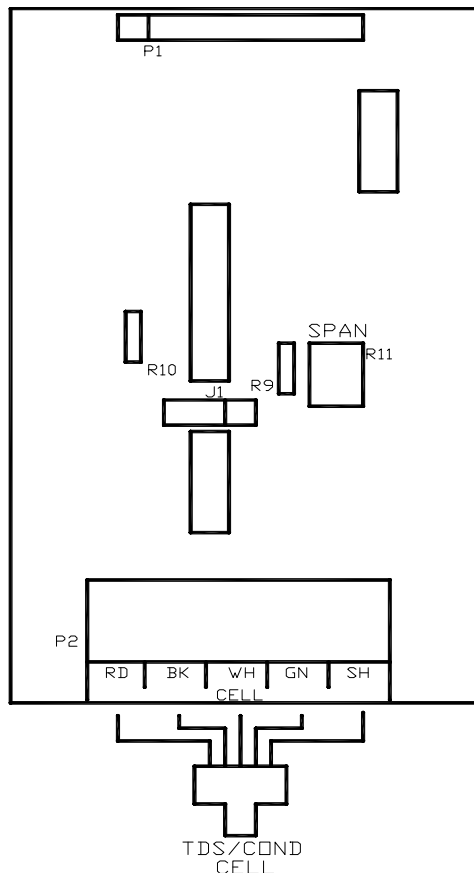

Figure 6

## SETPOINTS

When the expander is installed, 3 additional Setpoints are provided to allow features of the expander to be changed. Refer to the Displaying or Changing Setpoints section of the manual on page 42 for information on changing the Setpoints. The additional Setpoints are listed below.

SETPOINT	DESCRIPTION	RANGE	DEFAULT
C2 Range	Selects range of TDS / Conductivity monitor 0 – 50, 1 – 100, 2 – 250, 3 – 500, 4 – 1,000, 5 – 2,500, 6 – 5,000, 7 – 10,000 NOTE: If this Setpoint is changed, the unit must be recalibrated and range components may need to be changed.	0 – 7	2
C2 Limit	When this value is met or exceeded, the alarm lamp will light and high TDS / Conductivity will show on the display. To disable, set to zero.	0 – 9999 $\mu$ S or ppm	0
% Rejection	If the second TDS / Conductivity is used to monitor feedwater, programming this Setpoint to one allows the percentage of rejection to be displayed.	0 – 1	0

## OPERATION

When the TDS / Conductivity expander is installed, the reading will be shown on line two and will alternate every three to four seconds with the hours and temperature. If the percentage of rejection display is enabled, it will be shown on line two with the second TDS / Conductivity reading.

If the C2 limit is enabled, and the second TDS / Conductivity reading exceeds the limit programmed the C2 Limit Setpoint for the delay programmed in the TDS / Conductivity Delay Setpoint, the alarm lamp will light and the HI TDS / Conductivity 2 warning message will show on the display. This warning will clear when the second TDS / Conductivity drops below the Setpoint.

## CALIBRATION

Refer to Figure 6 for adjustment location. To calibrate the second TDS / Conductivity, place the cell in a known standard solution. Adjust the span adjustment for the correct reading. If the cell is installed, the unit can be calibrated by taking a sample of the water and testing it with a known, good meter. Adjust the span control until the reading matches the meter.

# MANUFACTURER'S DRAWINGS

## R1 – 1140 FLOW DIAGRAM

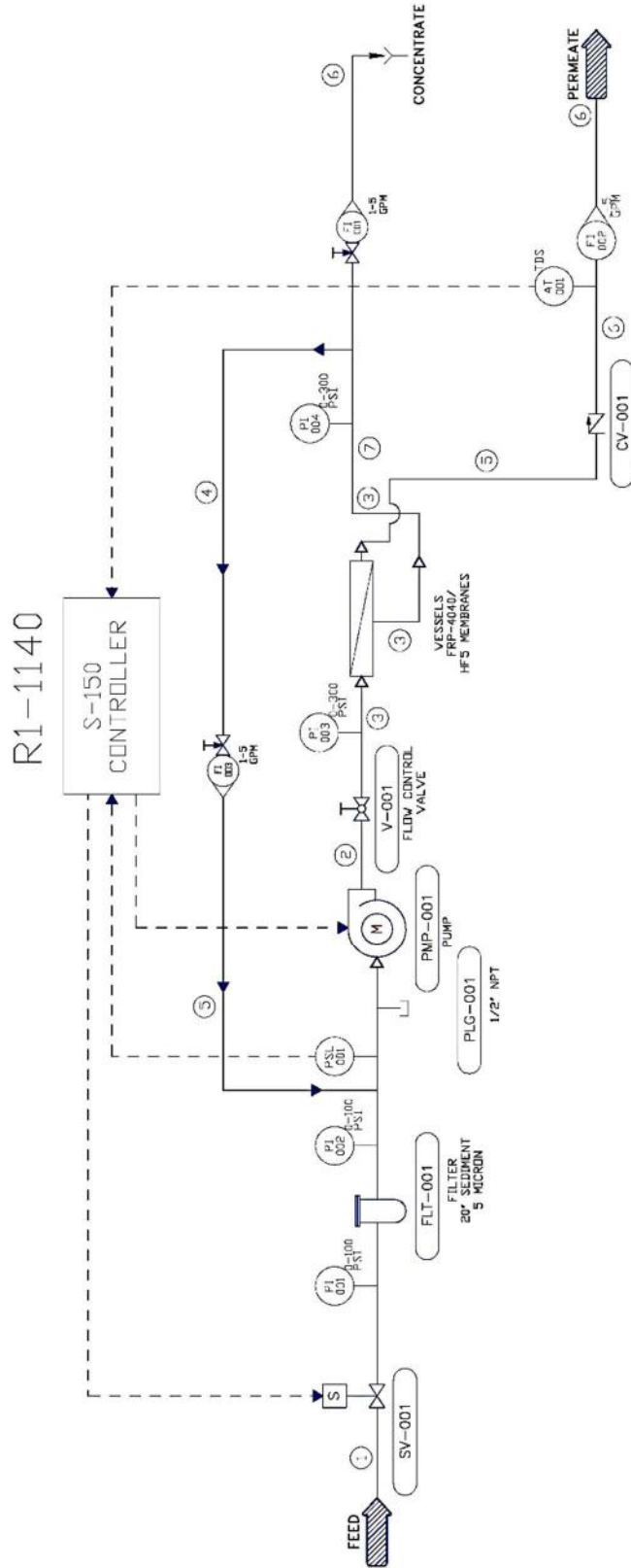

STREAM	SIZE	MATERIAL
1	1"	PVC (SCH. 80)
2	1"	SS
3	3/8"	POLY TUBE
4	1/2"	HP POLY TUBE
5	1/2"	LP POLY TUBE
6	3/4"	PVC (SCH. 80)
7	1/2"	SS

LINE SYMBOLS	
—	PIPING
---	PROCESS CONNECTION
---	ELECTRICAL SIGNAL

VALVE SYMBOLS	MISCELLANEOUS SYMBOLS	PRESSURE INDICATOR																		
<table border="0"> <tr> <td></td> <td></td> <td></td> </tr> <tr> <td></td> <td></td> <td></td> </tr> </table>							<table border="0"> <tr> <td></td> <td></td> <td></td> </tr> <tr> <td></td> <td></td> <td></td> </tr> </table>							<table border="0"> <tr> <td></td> <td></td> <td></td> </tr> <tr> <td></td> <td></td> <td></td> </tr> </table>						

# R1 - 2140 FLOW DIAGRAM

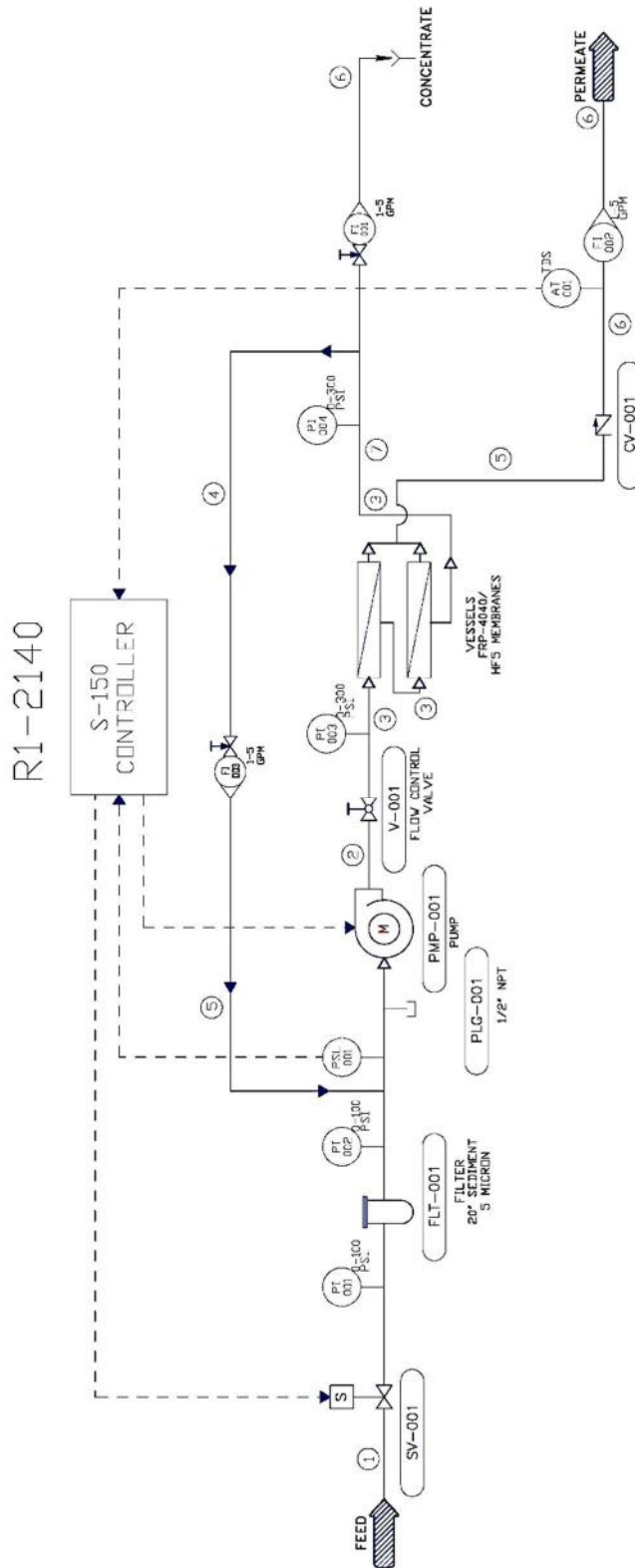

STREAM	SIZE	MATERIAL
1	1"	PVC (SCH. 80)
2	1"	SS
3	5/8"	PTLY TUBE
4	1/2"	HP PCLY TUBE
5	1/2"	LP PCLY TUBE
6	3/4"	PVC (SCH. 80)
7	1/2"	SS

LINE SYMBOLS	
PIPING	—————
PROCESS CONNECTION	—————
ELECTRICAL SIGNAL	-----

VALVE SYMBOLS	MISCELLANEOUS SYMBOLS	PRESSURE INDICATOR
SOLENOID VALVE	DRAIN	PRESSURE SWITCH/LOW
AUTO FLUSH VALVE	PLUG	TDS TRANSMITTER
GLOBE VALVE	FILTER	FLOW INDICATOR (NOT NEEDED)
NEEDLE VALVE	PUMP	FLOW INDICATOR (WITH NEEDLE/VALVE)
DOUBLE CHECK VALVE	MEMBRANE	
CHECK VALVE		

# R1 - 3140 FLOW DIAGRAM

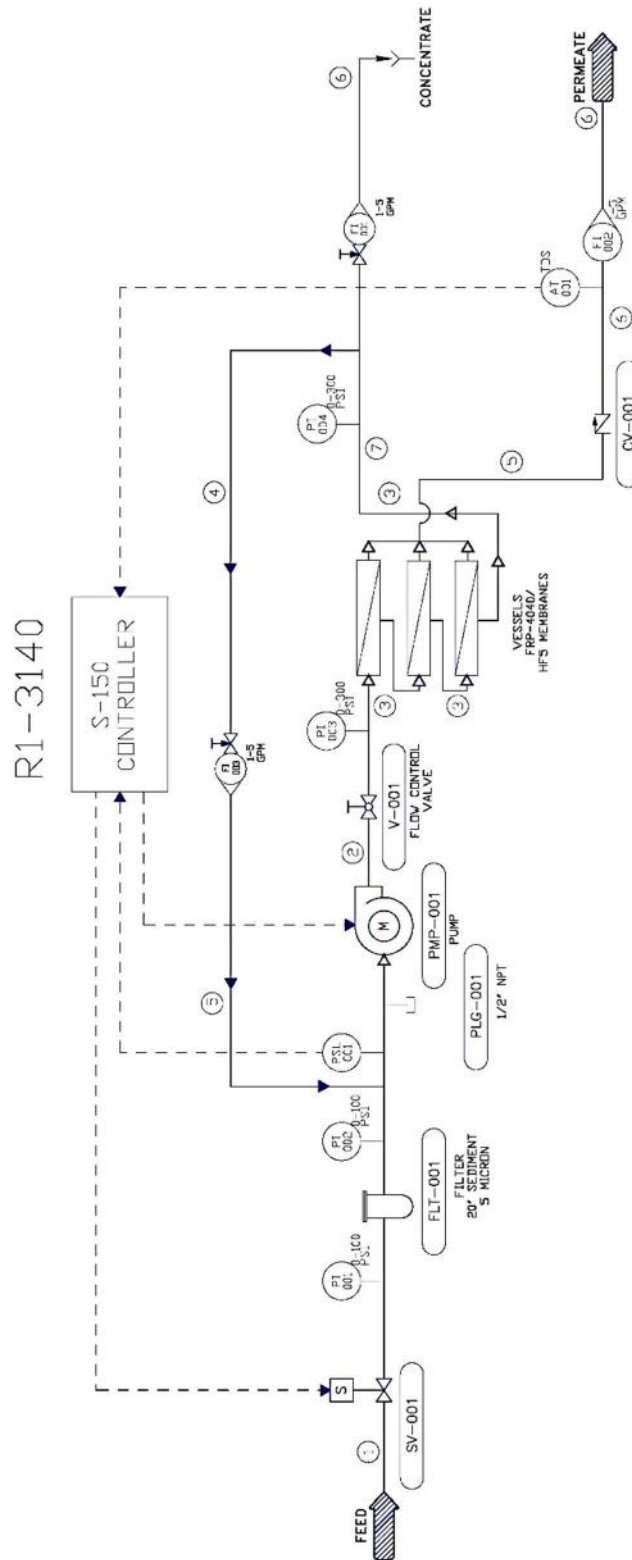

STREAM	SIZE	MATERIAL
1	1"	PVC (SCH. 80)
2	1"	SS
3	3/4"	POLY TUBE
4	3/4"	HP POLY TUBE
5	1/2"	LP POLY TUBE
6	3/4"	PVC (SCH. 80)
7	1/2"	SS

LINE SYMBOLS	
	PIPING
	PROCESS CONNECTION
	ELECTRICAL SIGNAL

VALVE SYMBOLS	MISCELLANEOUS SYMBOLS	MEMORANDUM



# R1 – 5140 FLOW DIAGRAM

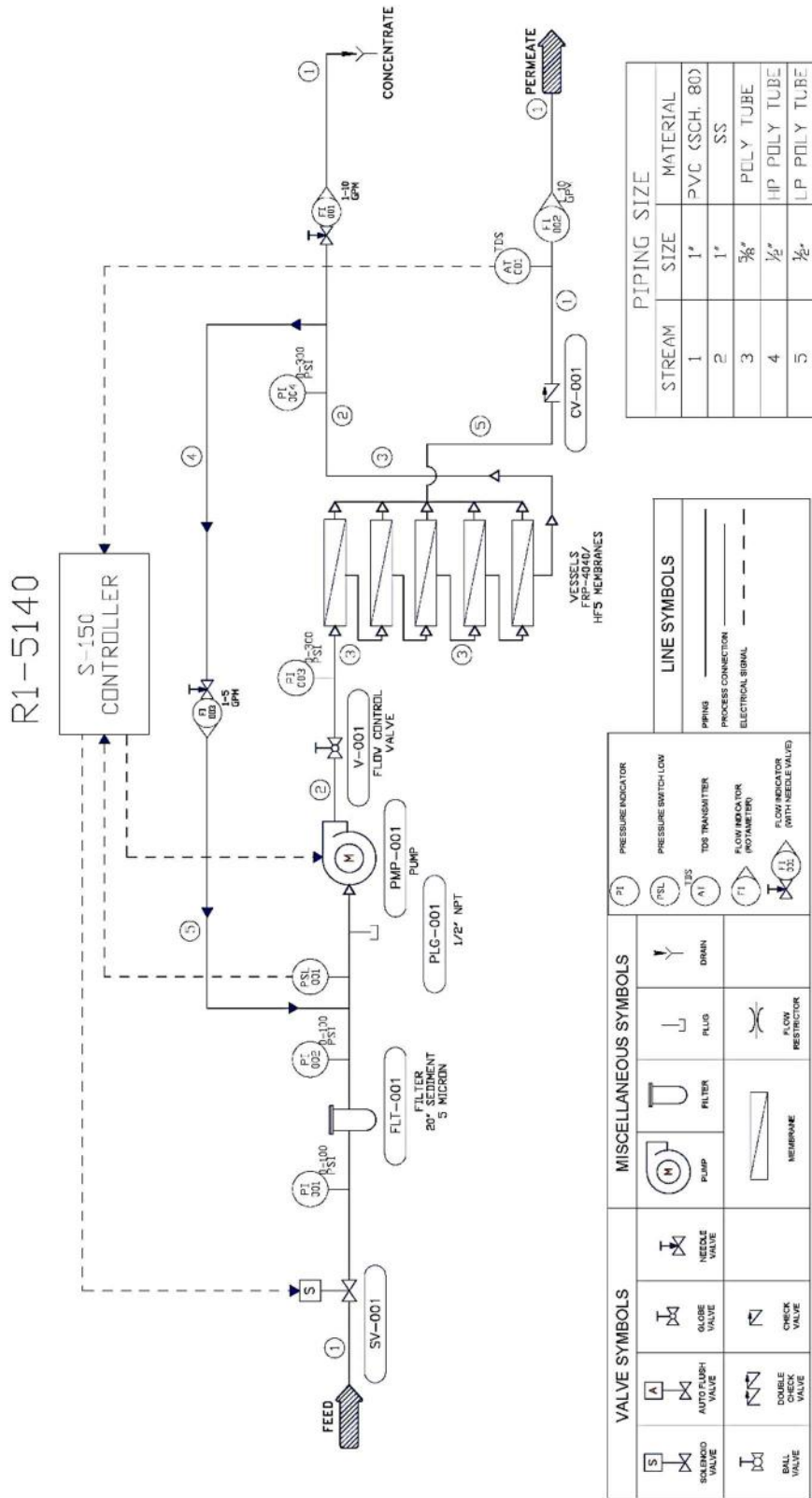

# R1 - 6140 FLOW DIAGRAM

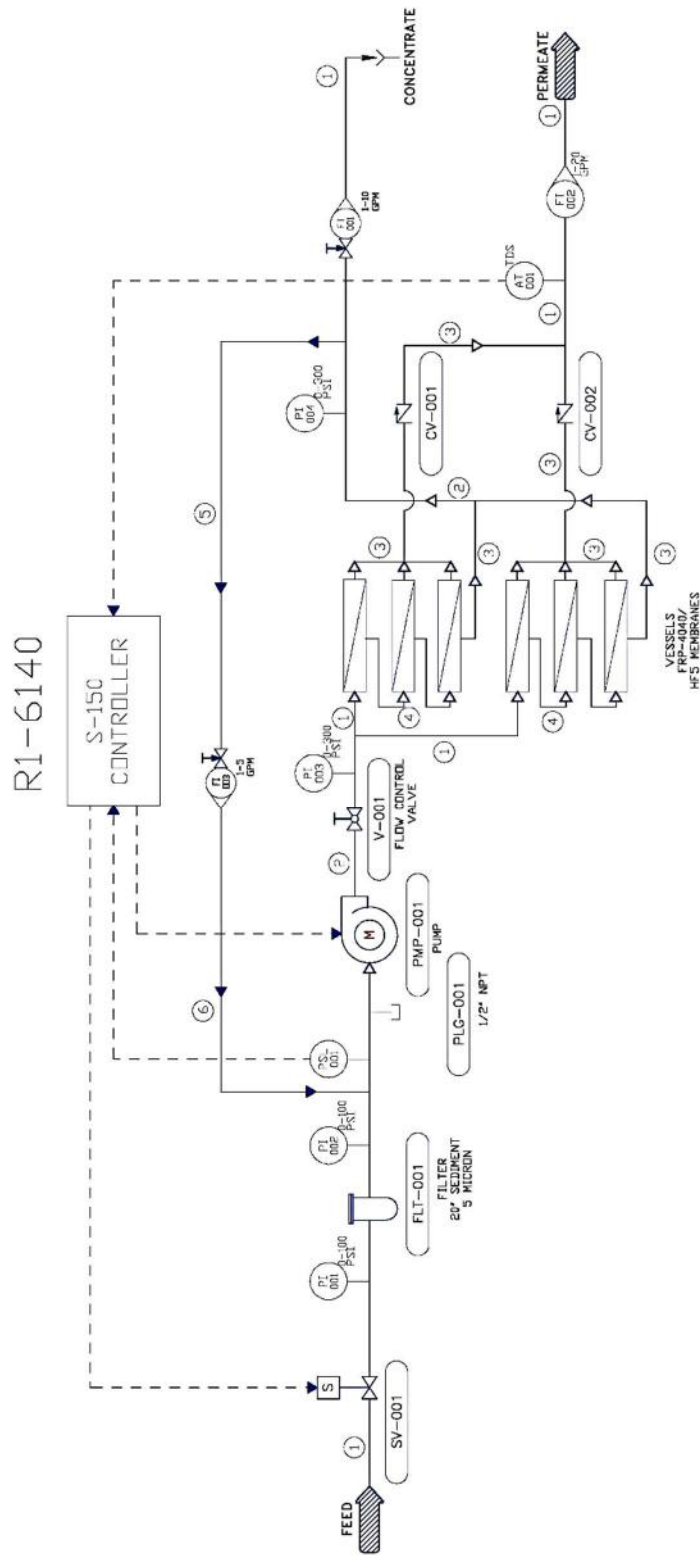

VALVE SYMBOLS	MISCELLANEOUS SYMBOLS	LINE SYMBOLS	PIPING SIZE	MATERIAL
			1"	PVC (SCH. 80)
			1"	SS
			3/4"	POLY TUBE
			3/4"	PVC (SCH. 80)
			1/2"	HP POLY TUBE
				LP POLY TUBE



# R1 - 8140 FLOW DIAGRAM

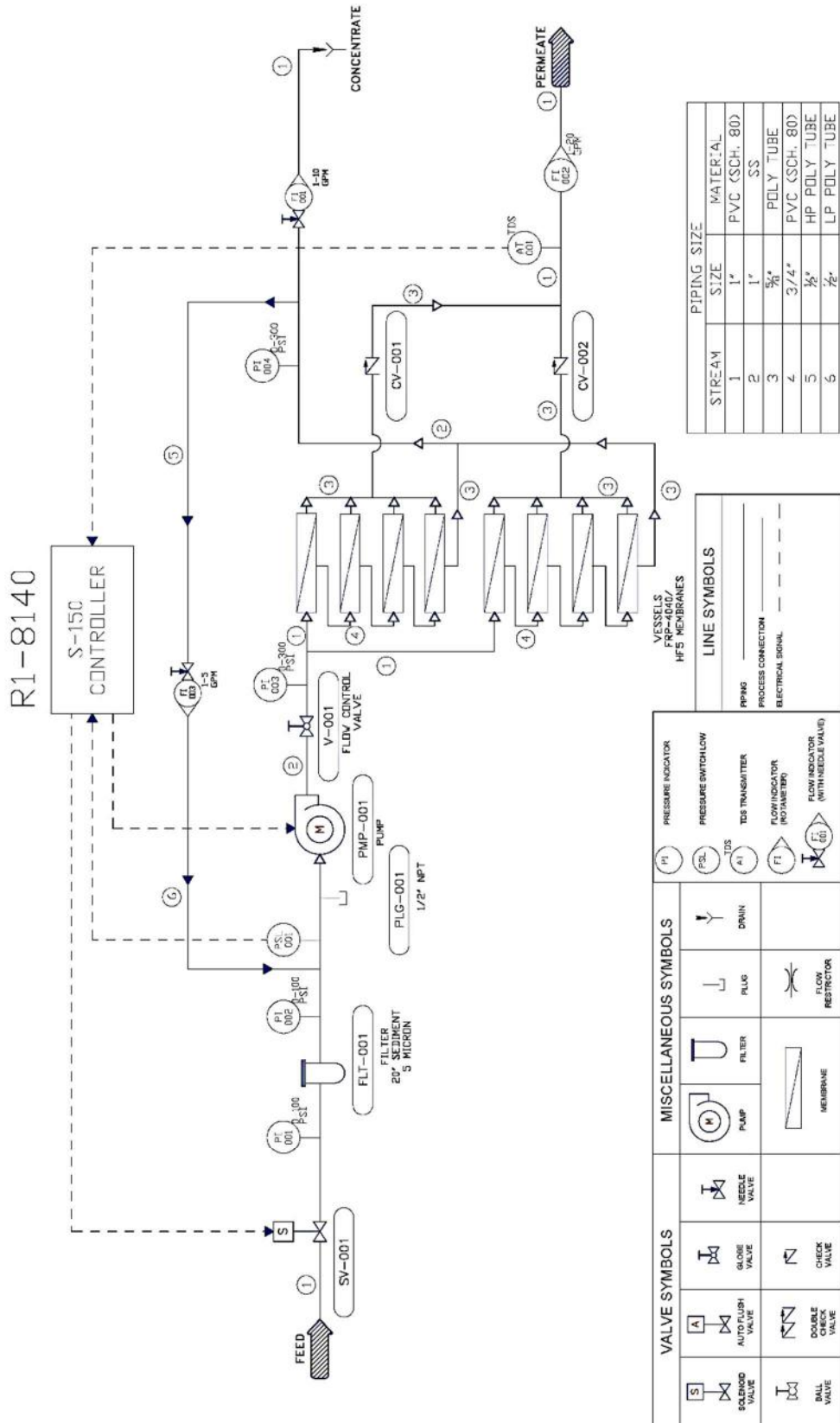

VALVE SYMBOLS		MISCELLANEOUS SYMBOLS		LINE SYMBOLS	

STREAM	SIZE	MATERIAL
1	1"	PVC (SCH. 80)
2	1"	SS
3	3/4"	POLY TUBE
4	3/4"	PVC (SCH. 80)
5	3/4"	HP POLY TUBE
6	1/2"	LP POLY TUBE



# R1 - 12140 FLOW DIAGRAM

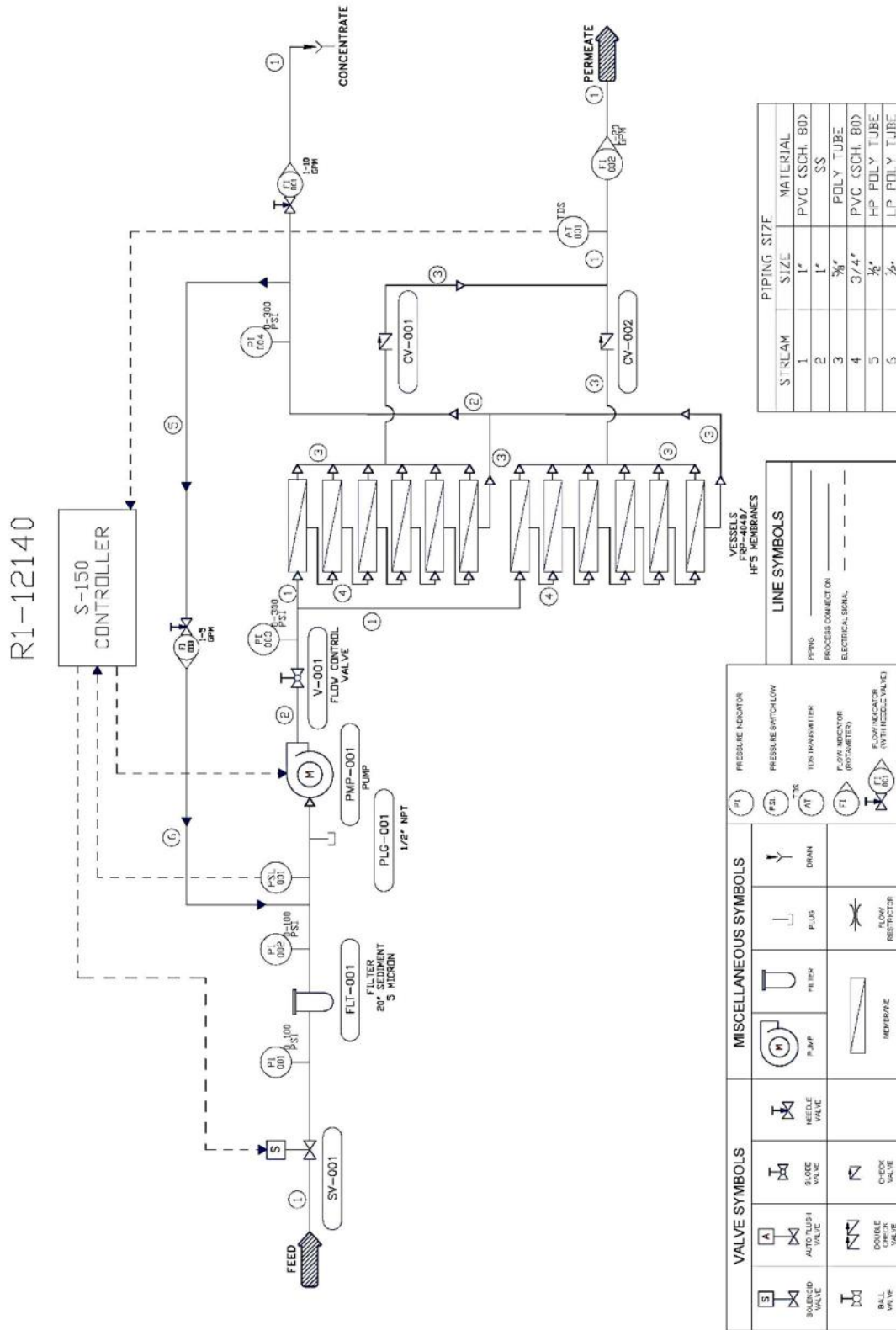

STREAM	PIPING SIZE	MATERIAL
1	1"	PVC (SCH. 80)
2	1"	SS
3	3/4"	POLY TUBE
4	3/4"	PVC (SCH. 80)
5	3/8"	H-P POLY TUBE
6	3/8"	L-P POLY TUBE

VESSELS FMP-001/002 HF5 MEMBRANES	
PPHNS	_____
PROCESS CONNECT ON	_____
ELECTRICAL SIGNAL	-----

VALVE SYMBOLS	MISCELLANEOUS SYMBOLS	LINE SYMBOLS
BALL VALVE DOUBLE CHECK VALVE GLOBE VALVE NEEDLE VALVE AUTO FLUSH VALVE	INDICATING MEMBRANE FILTER PLUS DRAIN	PRESSURE INDICATOR PRESSURE SWITCH LOW TDS TRANSMITTER FLOW INDICATOR (ROTAMETER) FLOW INDICATOR (WITH H2O2 VALVE)

# SYSTEM WARRANTY

## One-Year Limited Warranty

### Warranty Terms

Subject to the terms and conditions set forth hereinafter, the manufacturer (hereafter "Manufacturer") warrants to the original purchaser (hereafter the "Customer") that the systems and products manufactured by the Manufacturer are free from defects in material and in workmanship for twelve (12) months from the Warranty Commencement Date (as defined below) only when used strictly in accordance with the applicable operating instructions and within the range of the operating conditions specified by the Manufacturer for each such product.

This Warranty does not extend to systems, equipment, or components manufactured by others, nor to systems, equipment, or components manufactured by others and distributed by the Manufacturer. This Warranty does not extend to equipment or components manufactured by others which have been incorporated into a Manufacturer product but, if allowable the, Manufacturer hereby assigns, without warranty, to the Customer its interest, if any, under any Warranty made by the Manufacturer of such equipment or component. This Warranty does not cover disposable items such as fuses, O-rings, regeneration materials/chemicals, or other such disposable items, which must be replaced periodically under the normal and foreseeable operating conditions of the goods warranted hereby.

### Warranty Commencement Date

The Warranty Commencement Date for each Manufacturer product shall be the later of the date of: (1) receipt by the Customer, or (2) the date of installation at the Customer's premises provided that such installation must occur within three (3) months of shipment from the Manufacturer's manufacturing facility. In no event shall the Warranty Commencement Date exceed three (3) months from the shipment from the Manufacturer's manufacturing facility. The Customer shall provide proof of purchase in order to exercise rights granted under this Warranty. If requested by the Manufacturer, the Customer must also provide proof of the installation date. Proof of installation shall be returned by Customer to the Manufacturer within thirty (30) days after installation by virtue of supplying a Warranty Validation Card supplied with each Manufacturer product fully completed and signed in ink by Customer and the authorized installer of the product.

### Warranty Service

THE MANUFACTURER'S OBLIGATION UNDER THIS WARRANTY IS LIMITED TO THE REPAIR OR REPLACEMENT (AT MANUFACTURER'S SOLE DISCRETION) OF ANY PRODUCT, OR COMPONENT THEREOF, PROVED TO BE DEFECTIVE IN MATERIAL OR WORKMANSHIP WITHIN THE COVERED WARRANTY PERIOD.

The Customer, at the Customer's risk and expense, shall be responsible for returning such product or component, only after obtaining a Return Goods Authorization (RGA) number from the Manufacturer, arranging for freight prepaid, and in conformance with any special packaging and shipping instructions set forth on the operation documentation or RGA instructions, or as otherwise reasonably required, to the Manufacturer, together with (1) RGA number issued by the Manufacturer at Customer's request; (2) proof of purchase and, if necessary, proof of installation date; (3) a Return Goods Authorization Form; (4) a description of the suspected defects; (5) the serial number of the Manufacturer product alleged to be defective; and (6) a description of the type of water and pretreatment equipment which has been utilized in connection with the product, if any. The Manufacturer shall, in the Manufacturer's reasonable discretion, be the sole judge of whether a returned product or component is defective in material or workmanship. Required or replaced products or components shall be returned surface freight. In genuine emergency situations, the Manufacturer will (at the Manufacturer's sole discretion) forward replacement parts to the Customer without waiting for authorized return of the questionable part(s). In such cases, Customer will issue a purchase order or other payment guarantee prior to shipment. If the returned part is found to have been misused or abused, or the defective part is not received by the Manufacturer within thirty (30) days; the Customer will be invoiced for the replacement part(s) provided. This Warranty does not cover or include labor and/or travel to the Customer's premise or location or any other location. Charges of \$1000 per day plus associated travel expenses will be incurred by the Customer in providing the Warranty Service at any location other than the Manufacturer's main headquarters; that is if the Manufacturer deems that the product is not covered by said Warranty. The Manufacturer reserves the right to precondition such travel to Customer's premises upon prepayment of the Manufacturer's anticipated costs of attending such premises.

## Voidability of Warranty

This Warranty shall be void and unenforceable as to any Manufacturer product which has been damaged by accident, mishandling, abuse or has been repaired, modified, altered, disassembled or otherwise tampered with by anyone other than the Manufacturer or an authorized Manufacturer service representative; or, if any replacement parts are not authorized by the Manufacturer have been used, or, the product has not been installed, operated and maintained in strict accordance and adherence with the operating documentation and manuals for such product. Any expressed Warranty, or similar representation of performance set forth in the operation documentation for media or resin incorporated into the Manufacturer product shall be void and unenforceable unless the feedwater requirements set forth in the operating documentation for such product are unequivocally and strictly adhered to.

## Limitations and Exclusions

THIS WARRANTY AND REMEDIES DESCRIBED HEREIN AND HEREINABOVE ARE EXCLUSIVE AND IN LIEU OF ANY AND ALL OTHER WARRANTY OR REMEDIES, EXPRESSED OR IMPLIED, INCLUDING WITHOUT LIMITATION, ANY IMPLIED WARRANTY OF MERCHANTABILITY OR FITNESS FOR A PARTICULAR PURPOSE. IN NO EVENT SHALL THE MANUFACTURER BE LIABLE FOR ANY CONSEQUENTIAL, INCIDENTAL OR OTHER SIMILAR TYPES OF DAMAGES, DAMAGES FOR THE LOSS OF PRODUCTION OR PROFITS, OR INJURY TO PERSON OR PROPERTY. NO PERSON HAS ANY AUTHORITY TO BIND THE MANUFACTURER TO OTHER THAN WHAT IS SET FORTH ABOVE.

THIS WARRANTY GIVES THE CUSTOMER SPECIFIC LEGAL RIGHTS AND THE CUSTOMER MAY ALSO HAVE OTHER RIGHTS WHICH VARY FROM JURISDICTION TO JURISDICTION. THE PARTIES RECOGNIZE AND AGREE, THAT IN ALL RESPECTS THE LAWS OF THE STATE OF CALIFORNIA SHALL APPLY TO AND SHALL GOVERN ANY INTERPRETATION OR LEGAL SIGNIFICANCE OF THIS DOCUMENT.

NO WARRANTY OR OTHER LIABILITY OF THE MANUFACTURER TO CUSTOMER UNDER THIS AGREEMENT OR OTHERWISE WILL IN ANY EVENT EXCEED THE COST OF REPLACEMENT OF THE APPLICABLE MANUFACTURER PRODUCT, PART, OR ACCESSORY THAT IS SUBJECT TO ANY BREACH OF THE MANUFACTURER'S WARRANTY. THE MANUFACTURER WILL NOT BE LIABLE FOR ANY DAMAGE TO ANY PROPERTY OF CUSTOMER OR TO CUSTOMER'S CUSTOMERS FOR ANY CONSEQUENTIAL, INCIDENTAL, OR ECONOMIC LOSS OR COMMERCIAL DAMAGE WHATSOEVER. REMEDIES HEREIN PROVIDED ARE EXPRESSLY MADE THE SOLE AND EXCLUSIVE REMEDIES FOR BREACH OF ANY WARRANTY OR OTHER OBLIGATION HEREUNDER EXPRESS OR IMPLIED OR FROM THE OPERATION OF LAW.